

UTIFLEX®

FLEXIBLE MICROWAVE CABLE ASSEMBLIES



UFA125A-0-0300-100110
FSCM 64639 S/N98G0123

293C-0-0300-380300
M 64639 S/N98F0960

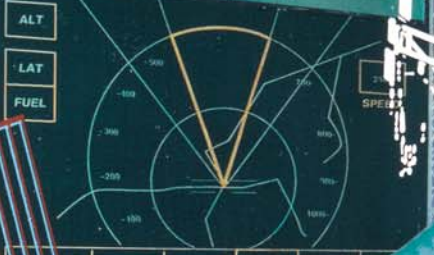

MICRO-COAX®

Leading the way in transmission line solutions.

MICRO-COAX has led the way in transmission line solutions for over 40 years. The Company's name has evolved, along with its capabilities, from the Micro Delay Division of Uniform Tubes to *MICRO-COAX*. Our sales offices are located throughout the world, but all design and manufacturing are performed in our 90,000 sq. ft. facility located in Pottstown, Pennsylvania.

The Company's initial products, semi-rigid coaxial cable and delay lines, are today part of a growing line of microwave components that include UTiFLEX high performance flexible microwave cables. Because *MICRO-COAX* has a very broad offering of transmission line products, we can provide the best solution to your transmission line needs. Our experienced Engineering staff has the capability to custom design cable and connectors to meet your most demanding and time sensitive requirements.

MICRO-COAX enjoys an outstanding reputation for service and product quality throughout the industries it serves. In fact, that commitment is rooted in our emphasis on quality, which is evident in our ISO 9002 and ISO 9001:2000 certifications. Statistical Process Control (SPC) techniques are employed throughout the facility to monitor both service and product quality with the goal of continuous improvement.

MICRO-COAX maintains complete control over all processes by manufacturing all of our own cable, cable assemblies, and many connectors. This is further enhanced by continuous investment in new products and processes with the goal of responding faster and bringing better products and services to the microwave transmission line market.

The products offered by *MICRO-COAX* today serve more applications than ever before. Our products can be found in systems ranging from military communications, radar, missile guidance, and satellites, to cellular telephones, cellular transmitters and receivers, and a wide range of test equipment. When you want the most innovative transmission line solutions, there's just one name to remember: *MICRO-COAX*.





Table of Contents

	Page
Introduction	2
Typical Cable Construction	3
Cable Selection Guide	4-5
Connector Selection Guide	6
Armor Selection Guide	7
UTiFLEX Miniature Low Loss Cable Assemblies	8-9
UTiFLEX Low Loss Cable Assemblies	10-11
UTiFLEX Ultra Low Loss Cable Assemblies	12-13
UTiFLEX Ultralight Cable Assemblies	14-15
Environmental Characteristics	16
Part Number Designation	17
Helpful Formulas	18
Cable Assembly Care and Handling	18
Service and Ordering Information	19
UTiFLEX Request for Quote Form	20
Other Products	21

Introduction

UTiFLEX is a complete line of high performance flexible microwave cables built by MICRO-COAX. The entire UTiFLEX product line is constructed using a low or ultra low density PTFE dielectric offering excellent loss characteristics, outstanding phase stability, and unsurpassed flexibility compared to standard flexible cables – all without sacrificing mechanical integrity. MICRO-COAX has greatly increased connector reliability through a unique patented connector attachment that withstands mechanical and thermal stresses far better than standard connectors. With UTiFLEX, the connector is no longer the weak link in your flexible cable assembly.

Microwave cable for almost any application:

- Versatile Low Loss cables offer outstanding performance in almost any environment.
- Ultra Low Loss cables have the lowest insertion loss available to 18, 26.5, and 40 GHz.
- Miniature cables are a superior alternative to traditional RG or semi-rigid cables.
- Ultralight cables provide up to 25% weight savings for spaceflight applications.

Key features:

- Low SWR (1.25:1 to 40 GHz typical)
- Excellent shielding effectiveness
- Precision phase matching
- Aracon® outer shield for superior weight savings on Ultralight cables

Space qualified:

- NASA certified assemblers and inspectors
- Class 100 and 10,000 clean room assembly processes
- Low-outgassing materials (1% TML, 0.1% CVCM per ASTM E-595)
- Radiation resistant up to 30 Mrads
- Real time x-ray capability

UTiFLEX high performance cable assemblies are manufactured in Pottstown, PA, under the guidance of our professional Engineering staff. Every cable assembly is tested for insertion loss and SWR and shipped with an individual test certificate.



Aracon® is a DuPont registered trademark.



Typical Cable Construction

UTiFLEX is designed to minimize both reflective and transmission losses while maximizing phase and amplitude stability. This is accomplished by carefully controlling all materials and processes used to manufacture the cable. Following is a description of the typical cable construction. Many other designs are available to meet your unique requirements.



CENTER CONDUCTOR

Solid or stranded silver-plated copper wire per ASTM B-298. In comparison to equal size center conductors, the solid center conductor has less RF resistance, lower attenuation, and is more amplitude stable with flexure. The stranded center conductor is more flexible and more phase stable with flexure.

DIELECTRIC

Low density PTFE per MIL-C-17, with a dielectric constant ranging from 1.4 to 1.7 depending on the cable type. Most transmission losses are caused either directly or indirectly by the dielectric. In addition, the dielectric determines the velocity of propagation, temperature range, power rating, phase and amplitude stability, and contributes to cable flexibility. The UTiFLEX PTFE dielectric is ideal for these critical parameters due to its low density and low thermal coefficient of expansion.

INNER SHIELD

Silver-plated copper tape per ASTM B-298, helically wrapped with 40% minimum overlap between layers. This shield allows for outstanding flexibility while providing 100% coverage. By closely monitoring the precision wrapping process and carefully matching the elasticity of the dielectric to the properties of the silver-plated copper tape, uniform impedance and ideal contact between individual layers of the shield are maintained.

OUTER SHIELD

Silver-plated copper wire per ASTM B-298, tightly braided over the inner shield. The braids are primarily a strength member that also add additional RF shielding. For applications where weight is critical such as spaceflight, MICRO-COAX offers DuPont Aracon® as the braiding material.

JACKET

Fluorinated Ethylene Propylene (FEP), colored light aqua blue. The FEP is excellent because of its high temperature resistance and chemical inertness. Other jacket materials are available such as Tefzel® and carbon loaded Tefzel® for spaceflight applications.

Tefzel® is a DuPont registered trademark.

In order to simplify the cable selection process, individual cables have been grouped into product families. Most flexible cable users want minimal insertion loss consistent with smallest size and weight without sacrificing flexibility. Other parameters will influence price and performance. Use the table and information below to select the cable that best suits your needs.

- Cables with stranded center conductors tend to be more phase stable with flexure.
- Cables with solid center conductors tend to be more amplitude stable with flexure.

- For applications less than 26.5 GHz, start with the Low Loss UFA210A cable.
 - If the cable will be used in a test lab environment, consider the Low Loss UFA210B due to its longer flex life and better phase stability with flexure.
 - If lower insertion loss is required, Ultra Low Loss UFB205A or UFB197C should be chosen. If the application is less than 18 GHz, choose the Ultra Low Loss UFB311A or UFB293C.
 - If size and flexibility are critical, consider the Low Loss UFA147B or Ultra Low Loss UFB142C cables.

MINIATURE LOW LOSS

PART NUMBER		UGN070D	UFF092D	UFF092F
Impedance	ohms	50	50	50
Max. Frequency	GHz	18	18	18
Max. Insertion Loss dB/ft (meters)	1 GHz	0.35 (1.15)	0.21 (0.69)	0.23 (0.76)
	10 GHz	1.12 (3.67)	0.67 (2.20)	0.76 (2.49)
	18 GHz	1.52 (4.99)	0.92 (3.02)	1.03 (3.38)
Power Handling	watts (CW) @ 10 GHz	30	59	55
Nominal Outer Dia.	inch (mm)	0.070 (1.78)	0.092 (2.34)	0.092 (2.34)
Nominal Weight	grams/ft (meter)	3 (9.8)	5 (16.4)	5 (16.4)
Center Conductor	type	solid	solid	stranded
Static Bend Radius	inch (mm)	0.10 (2.54)	0.13 (3.18)	0.13 (3.18)
Detailed Information	page	8-9	8-9	8-9

LOW LOSS

PART NUMBER		UFA125A	UFA147A	UFA147B	UFA210A	UFA210B
Impedance	ohms	50	50	50	50	50
Max. Frequency	GHz	50	40	26.5	26.5	26.5
Max. Insertion Loss dB/ft (meters)	1 GHz	0.15 (0.49)	0.12 (0.39)	0.16 (0.53)	0.08 (0.26)	0.11 (0.36)
	10 GHz	0.49 (1.61)	0.40 (1.31)	0.52 (1.71)	0.28 (0.92)	0.36 (1.18)
	18 GHz	0.68 (2.23)	0.55 (1.81)	0.72 (2.36)	0.39 (1.28)	0.50 (1.64)
	26.5 GHz	0.84 (2.76)	0.68 (2.23)	0.89 (2.92)	0.49 (1.61)	0.62 (2.03)
	40 GHz	1.06 (3.48)	0.87 (2.85)	-	-	-
	50 GHz	1.21 (3.97)	-	-	-	-
Power Handling	watts (CW) @ 10 GHz	105	150	129	286	248
Nominal Outer Dia.	inch (mm)	0.125 (3.18)	0.147 (3.73)	0.147 (3.73)	0.210 (5.33)	0.210 (5.33)
Nominal Weight	grams/ft (meter)	8 (26.2)	11 (36.1)	11 (36.1)	20 (65.6)	20 (65.6)
Center Conductor	type	solid	solid	stranded	solid	stranded
Static Bend Radius	inch (mm)	0.20 (5.08)	0.25 (6.35)	0.25 (6.35)	0.38 (9.65)	0.38 (9.65)
Detailed Information	page	10-11	10-11	10-11	10-11	10-11

- For applications greater than 26.5 GHz but less than 40 GHz, start with the Low Loss UFA147A cable. If lower loss is required, choose the Ultra Low Loss UFB142A cable.
- For applications up to 50 GHz, use the Low Loss UFA125A cable.
- If the application is for a fixed installation, consider the Miniature cables due to their cost/size/performance ratio.
- In comparison to other product families, the Low Loss cables are the most durable and robust.



If you need assistance, please contact *MICRO-COAX*.

ULTRA LOW LOSS

PART NUMBER		UFB142C	UFB142A	UFB197C	UFB205A	UFB293C	UFB311A
Impedance	ohms	50	50	50	50	50	50
Frequency Range	GHz	18	40	26.5	26.5	18	18
Max. Insertion Loss dB/ft (meters)	1 GHz	0.12 (0.39)	0.11 (0.36)	0.09 (0.30)	0.08 (0.26)	0.06 (0.20)	0.05 (0.16)
	10 GHz	0.38 (1.25)	0.33 (1.08)	0.30 (0.98)	0.28 (0.92)	0.19 (0.62)	0.15 (0.49)
	18 GHz	0.51 (1.67)	0.45 (1.48)	0.40 (1.31)	0.32 (1.05)	0.26 (0.85)	0.21 (0.69)
	26.5 GHz	-	0.55 (1.81)	0.49 (1.61)	0.39 (1.28)	-	-
	40 GHz	-	0.68 (2.23)	-	-	-	-
Power Handling	watts (CW) @ 10 GHz	161	172	281	328	540	643
Nominal Outer Dia.	inch (mm)	0.142 (3.61)	0.142 (3.61)	0.197 (5.00)	0.205 (5.21)	0.293 (7.44)	0.311 (7.90)
Nominal Weight	grams/ft (meters)	9 (29.5)	10 (32.8)	18 (59.1)	20 (65.6)	37 (121.4)	42 (137.8)
Center Conductor	type	stranded	solid	stranded	solid	stranded	solid
Static Bend Radius	inch (mm)	0.38 (9.65)	0.38 (9.65)	0.50 (12.70)	0.50 (12.70)	0.75 (19.05)	1.25 (31.75)
Detailed Information	page	12-13	12-13	12-13	12-13	12-13	12-13

ULTRALIGHT

		MCJ088D	MCJ142A	MCJ205A	MCJ311A
Impedance	ohms	50	50	50	50
Frequency Range	GHz	18	40	26.5	18
Max. Insertion Loss dB/ft (meters)	1 GHz	0.21 (0.69)	0.11 (0.36)	0.08 (0.26)	0.05 (0.16)
	10 GHz	0.67 (2.20)	0.33 (1.08)	0.23 (0.76)	0.15 (0.49)
	18 GHz	0.90 (2.95)	0.45 (1.48)	0.32 (1.05)	0.21 (0.69)
	26.5 GHz	-	0.55 (1.81)	0.39 (1.28)	-
	40 GHz	-	0.68 (2.23)	-	-
Power Handling	watts (CW) @ 10 GHz	60	172	328	643
Nominal Weight*	grams/ft (meters)	3.3 (10.8)	7.0 (23.0)	15 (49.2)	33 (108.3)
Nominal Outer Dia.	inch (mm)	0.088 (2.24)	0.142 (3.61)	0.205 (5.21)	0.311 (7.90)
Center Conductor	type	solid	solid	solid	solid
Static Bend Radius	inch (mm)	0.25 (6.35)	0.38 (9.65)	0.50 (12.70)	1.25 (31.75)
Detailed Information	page	14-15	14-15	14-15	14-15

*Ultralight cables are also available with an aluminum center conductor which offers an additional weight savings of up to 10% depending on cable type.



Connector Selection Guide

MICRO-COAX specializes in custom, high-performance connector versions that cannot be obtained from conventional sources. Please contact us to discuss your unique and demanding connector requirements.

Design and materials of all connectors and connector parts conform to MIL-C-39012. The UTIFLEX connectors have been optimized to achieve the lowest possible SWR across the bandwidth. In addition, the patented connector attachment has been designed to provide high reliability and withstand heavy stress. The connector body, dielectric, and center contact are completely captivated guaranteeing the cable assembly will keep its excellent properties even after hard use.

DESCRIPTION	PART NUMBER	CABLE GROUP*	MAXIMUM FREQUENCY	MAXIMUM SWR (PER CONNECTOR)
2.4 mm Plug	100	04,05	40/50 GHz	1.16:1 to 18 GHz 1.22:1 to 40/50 GHz
2.4 mm Jack	110	04,05	40/50 GHz	1.16:1 to 18 GHz 1.22:1 to 40/50 GHz
K Plug	200	05	40 GHz	1.16:1 to 18 GHz 1.20:1 to 40 GHz
K Jack	210	05	40 GHz	1.16:1 to 18 GHz 1.20:1 to 40 GHz
Precision 3.5 mm Plug	000	05,07	26.5 GHz	1.16:1 to 18 GHz 1.20:1 to 26.5 GHz
Precision 3.5 mm Jack	010	05,07	26.5 GHz	1.16:1 to 18 GHz 1.20:1 to 26.5 GHz
Test Port Precision 3.5 mm Jack	070	07	26.5 GHz	1.16:1 to 18 GHz 1.20:1 to 26.5 GHz
SMA Plug	300	01,02,05,06,07,08	18 GHz	1.16:1 to 18 GHz
SMA Jack	310	01,02,05,06,07,08	18 GHz	1.16:1 to 18 GHz
SMA Right Angle Plug	380	02,05,06,07,08	18 GHz	1.20:1 to 18 GHz
SMA Bulkhead Jack	320	02,05,06,07	18 GHz	1.16:1 to 18 GHz
Precision 7 mm	460	05,06,07,08	18 GHz	1.16:1 to 18 GHz
Precision N Plug	504	05,06,07,08	18 GHz	1.16:1 to 18 GHz
Precision N Jack	510	05,06,07,08	18 GHz	1.16:1 to 18 GHz
Precision TNC Plug	603	05,06,07,08	18 GHz	1.20:1 to 18 GHz
Precision TNC Jack	610	05,06,07,08	18 GHz	1.20:1 to 18 GHz
N Plug	704	07,08	12.4 GHz	1.16:1 to 12.4 GHz
N Jack	710	07,08	12.4 GHz	1.16:1 to 12.4 GHz
BNC Plug	804	07	4 GHz	1.20:1 to 4 GHz
SMP Jack	F10	01,02,04	18 GHz	1.16:1 to 18 GHz
SMP Right Angle Jack	F80	01,02,04	18 GHz	1.20:1 to 18 GHz

*CABLE GROUPS NUMBER

UGN070D	01
UFF092D, UFF092F, MCJ088D	02
UFA125A	04
UFA147A, UFB142A	05
UFA147B, UFB142C	06
UFA210A, UFA210B, UFB205A, UFB197C, MCJ205A	07
UFB311A, UFB293C, MCJ311A	08

Most connector types are also available in a right angle elbow configuration. Additional connector types (not listed) are available upon request.

Please contact *MICRO-COAX* for outline drawings or any special requirements.

A Armor Selection Guide

Most UTIFLEX cable assemblies are available with armor. The armor extends the assembly life and adds additional physical protection. Two standard armors are detailed below. Additional armor types are also available. Please contact *MICRO-COAX* with any special requirements.

-1 POLYURETHANE JACKET OVER BRAID / STAINLESS STEEL SPIRAL

Cable Groups (see page 6)	04,05,06	07	08
Diameter inch (mm)	0.35 (8.89)	0.41 (10.41)	0.53 (13.46)
Minimum Bend Radius inch (mm)	0.5 (12.70)	1.0 (25.40)	1.5 (38.10)
Maximum Temperature (Deg C)	80	80	80
Crush Resistance lbs./inch (Newton/mm)	450 (79.4)	450 (79.4)	450 (79.4)

Features:

Very Flexible
Waterproof and UV Resistant
Good Abrasion and
Cut Through Resistance
Torque Resistant and Adds Pull Strength



Typical Application:

Test Lab or Antenna Range

-2 STAINLESS STEEL INTERLOCKED HOSE

Cable Groups (see page 6)	04,05,06	07	08
Diameter inch (mm)	0.28 (7.11)	0.38 (9.65)	0.49 (12.45)
Minimum Bend Radius inch (mm)	1.5 (38.10)	2.0 (50.80)	2.0 (50.80)
Maximum Temperature (Deg C)	165	165	165
Crush Resistance lbs./inch (Newton/mm)	420 (74.1)	420 (74.1)	420 (74.1)

Features:

High Temperature
Prevents Over Bending
Excellent Abrasion and
Cut Through Resistance
Cost Effective



Typical Application:

Military Hardware



TiFLEX Miniature Low Loss Cable Assemblies

These general purpose microwave miniature cables have been designed to offer superior electrical performance in the smallest possible package for fixed installations. They are a cost-effective alternative when an RG cable cannot perform to your system needs or when a semi-rigid cable is too cumbersome. The TiFLEX Miniature cables are available with a large selection of connectors and can be easily customized to meet your exact requirements.

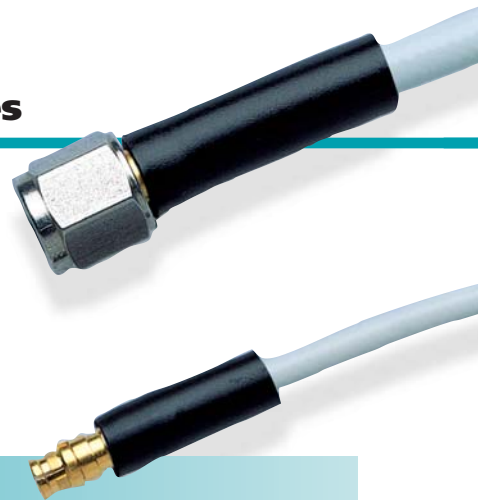

MECHANICAL CHARACTERISTICS

UTIFLEX TYPE	UGN070D	UFF092D	UFF092F
Outer Diameter inch (mm)	0.070 (1.78)	0.092 (2.34)	0.092 (2.34)
Center Conductor Type	Solid	Solid	Stranded
Weight grams/ft (meter)	3 (9.84)	5 (16.41)	5 (16.41)
Minimum Bend Radius inch (mm)	0.10 (2.54)	0.13 (3.18)	0.13 (3.18)

ELECTRICAL CHARACTERISTICS

Impedance (ohms)	50	50	50
Frequency Range (GHz)	DC-18	DC-18	DC-18
Velocity of Propagation	77%	77%	77%
Capacitance pf/ft (meter)	26.2 (86.0)	26.2 (86.0)	26.2 (86.0)
Shielding Effectiveness (dB @ 1 GHz)	> 100	> 100	> 100
Maximum Insertion Loss dB/ft (meter)	See figure on next page		
1 GHz	0.35 (1.15)	0.21 (0.69)	0.23 (0.76)
10 GHz	1.12 (3.67)	0.67 (2.20)	0.76 (2.49)
18 GHz	1.52 (4.99)	0.92 (3.02)	1.03 (3.38)
Phase Stability vs Flexure*			
10 GHz	2°	3°	2°
18 GHz	4°	5°	2°
Phase Stability vs Temperature	See figure on next page		
Power Handling	See figure on next page		
VSWR	Contact Factory		

*Cable wrapped around a 2 inch diameter mandrel

ENVIRONMENTAL CHARACTERISTICS

Temperature Range (Deg C)	-65/+165	-65/+165	-65/+165
---------------------------	----------	----------	----------

See page 16 for applicable environmental test

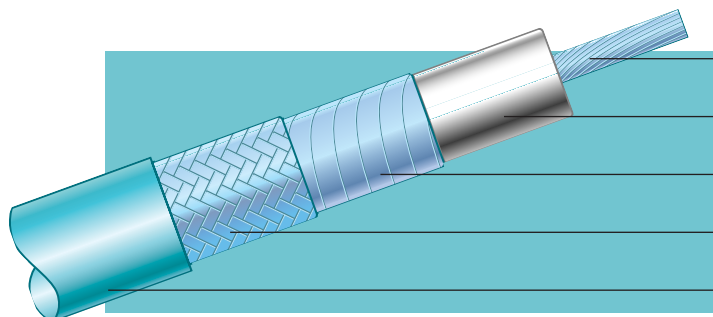

- Silver-Plated Copper Wire or Silver-Plated Copper Clad Steel Wire
- Low Density PTFE Dielectric
- Silver-Plated Copper Shield**
- Silver-Plated Copper Braid
- FEP Jacket**

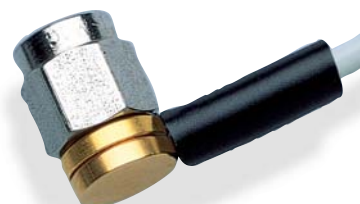

**Not typical for UGN070D

Electrical Characteristics

MAXIMUM INSERTION LOSS

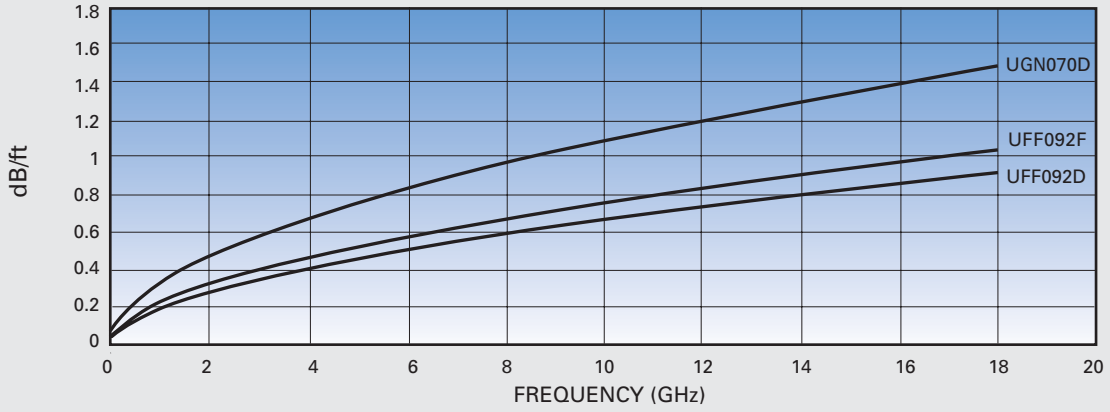

PHASE STABILITY VS. TEMPERATURE

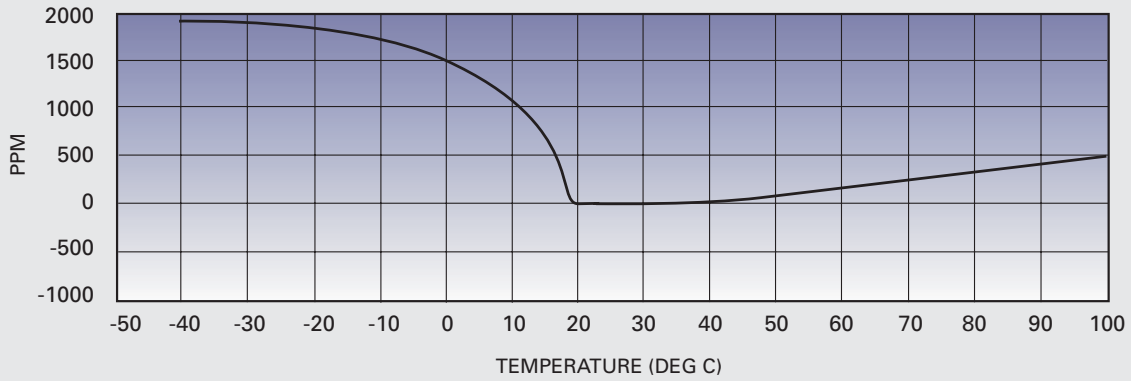

POWER HANDLING

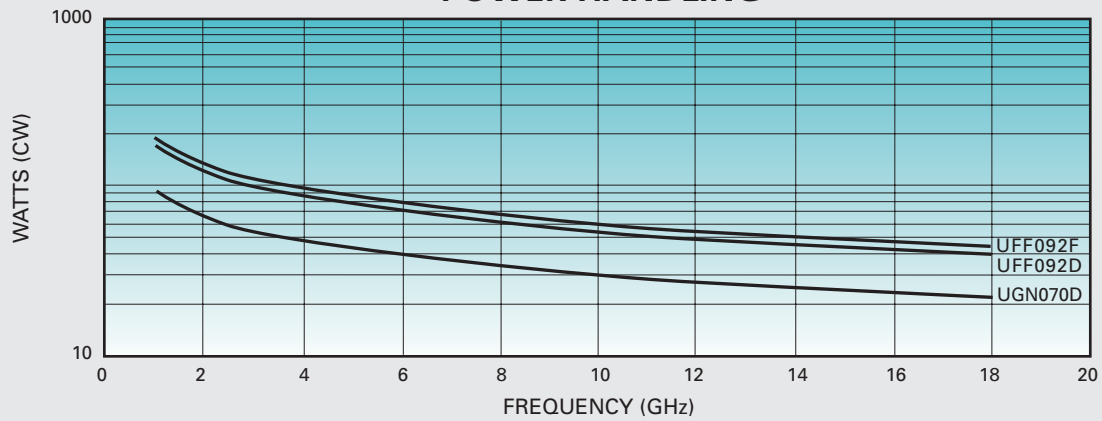



TiFLEX Low Loss Cable Assemblies

UTiFLEX Low Loss cable assemblies provide you with the complete high performance microwave cable. They have outstanding mechanical integrity without sacrificing insertion loss, phase stability, or SWR. UTiFLEX Low Loss cable assemblies are extremely versatile, moderately priced, and fit a large variety of applications.



MECHANICAL CHARACTERISTICS

UTiFLEX TYPE	UFA125A	UFA147A	UFA147B	UFA210A	UFA210B
Outer Diameter inch (mm)	0.125 (3.18)	0.147 (3.73)	0.147 (3.73)	0.210 (5.33)	0.210 (5.33)
Center Conductor Type	Solid	Solid	Stranded	Solid	Stranded
Weight grams/ft (meter)	8 (26.2)	11 (36.1)	11 (36.1)	20 (65.6)	20 (65.6)
Minimum Bend Radius inch (mm)	0.20 (5.08)	0.25 (6.35)	0.25 (6.35)	0.38 (9.65)	0.38 (9.65)
Flexures	10,000	10,000	100,000	10,000	100,000

ELECTRICAL CHARACTERISTICS

Impedance (ohms)	50	50	50	50	50
Frequency Range (GHz)	DC-50	DC-40	DC-26.5	DC-26.5	DC-26.5
Velocity of Propagation	77%	77%	77%	77%	77%
Capacitance pf/ft (meter)	26.2 (86.0)	26.2 (86.0)	26.2 (86.0)	26.2 (86.0)	26.2 (86.0)
Shielding Effectiveness (dB @ 1 GHz)	> 100	> 100	> 100	> 100	> 100
Maximum Insertion Loss dB/ft (meter)	See figure on next page				
1 GHz	0.15 (0.49)	0.12 (0.39)	0.16 (0.53)	0.08 (0.26)	0.11 (0.36)
10 GHz	0.49 (1.61)	0.40 (1.31)	0.52 (1.71)	0.28 (0.92)	0.36 (1.18)
18 GHz	0.68 (2.23)	0.55 (1.81)	0.72 (2.36)	0.39 (1.28)	0.50 (1.64)
26.5 GHz	0.84 (2.76)	0.68 (2.23)	0.89 (2.92)	0.49 (1.61)	0.62 (2.03)
40 GHz	1.06 (3.48)	0.87 (2.85)	-	-	-
50 GHz	1.21 (3.97)	-	-	-	-
Phase Stability vs Flexure*					
10 GHz	3°	3°	2°	3°	2°
18 GHz	5°	5°	2°	5°	2°
Phase Stability vs Temperature	See figure on next page				
Power Handling	See figure on next page				
VSWR	Refer to connector selection guide				

* Cable wrapped around a 2 inch diameter mandrel.

ENVIRONMENTAL CHARACTERISTICS

Temperature Range (Deg C)	-65/+165	-65/+165	-65/+165	-65/+165	-65/+165
---------------------------	----------	----------	----------	----------	----------

See page 16 for applicable environmental test

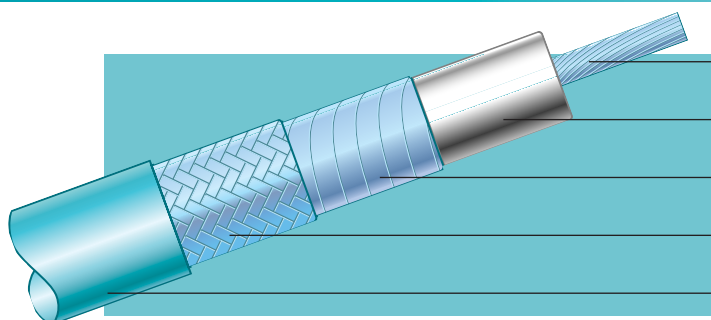

- Silver-Plated Copper Wire or Silver-Plated Copper Clad Steel Wire
- Low Density PTFE Dielectric
- Silver-Plated Copper Shield
- Silver-Plated Copper Braid
- FEP Jacket



Electrical Characteristics

MAXIMUM INSERTION LOSS

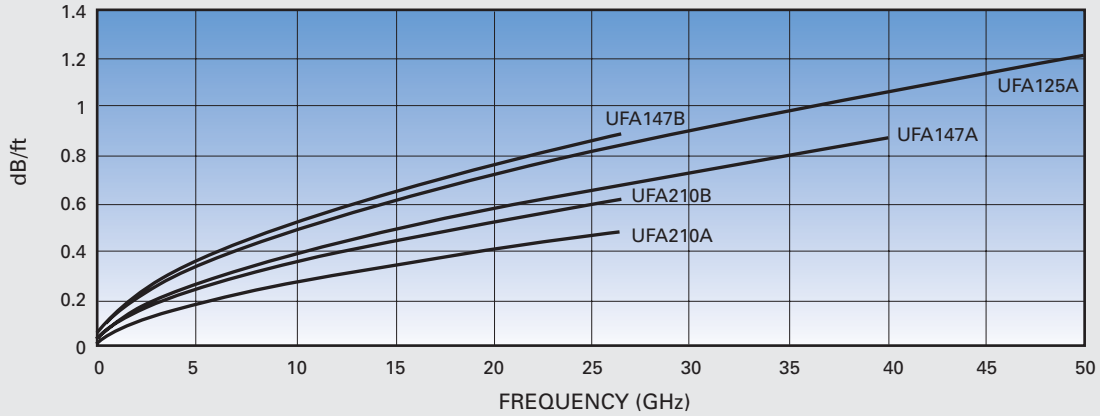

PHASE STABILITY VS. TEMPERATURE

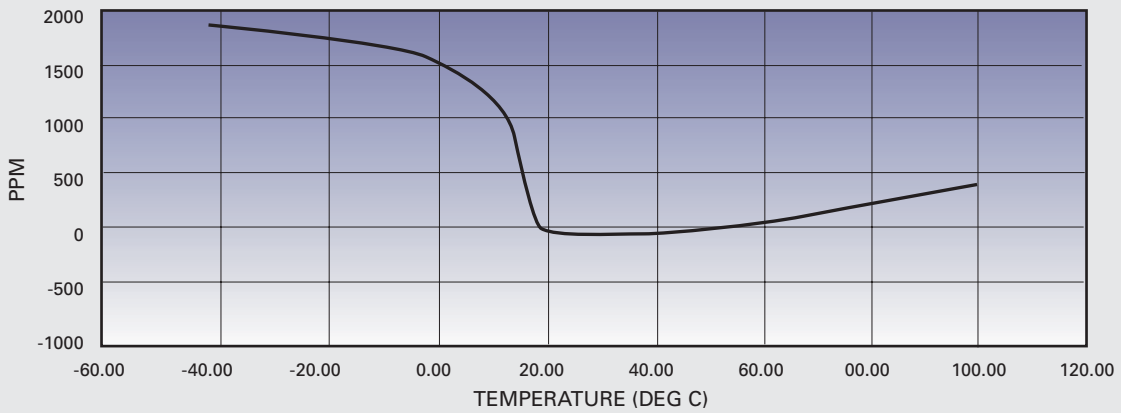

POWER HANDLING

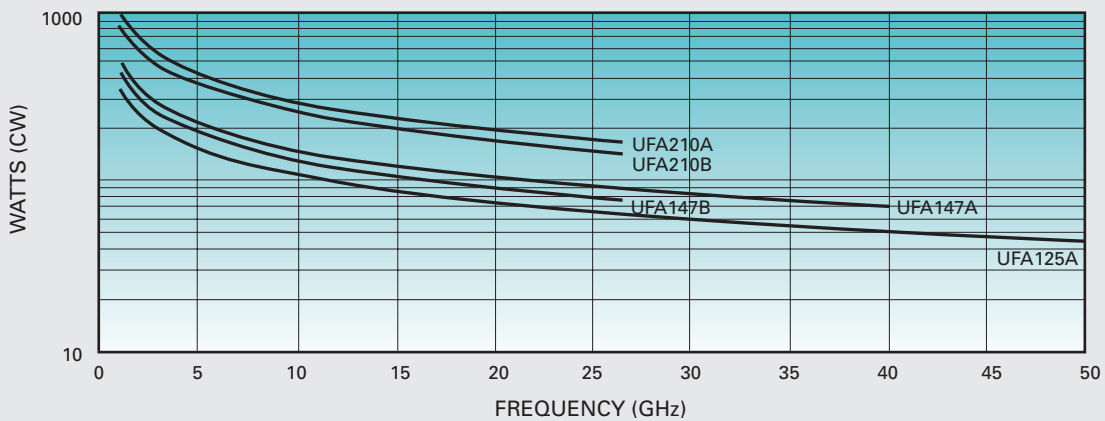



TiFLEX Ultra Low Loss Cable Assemblies

UTiFLEX Ultra Low Loss cable assemblies are optimized to provide the lowest insertion loss available in a flexible cable construction up to 18, 26.5, and 40 GHz. The cables utilize an ultra low density PTFE dielectric that lowers weight and insertion loss, improves electrical stability, and provides greater resilience and flexibility when compared to standard microwave cables.



MECHANICAL CHARACTERISTICS

UTiFLEX TYPE	UFB142C	UFB142A	UFB197C	UFB205A	UFB293C	UFB311A
Outer Diameter inch (mm)	0.142 (3.61)	0.142 (3.61)	0.197 (5.00)	0.205 (5.21)	0.293 (7.44)	0.311 (7.90)
Center Conductor Type	Stranded	Solid	Stranded	Solid	Stranded	Solid
Weight grams/ft (meter)	9 (29.5)	10 (32.8)	18 (59.1)	20 (65.6)	37 (121.4)	42 (137.8)
Minimum Bend Radius inch (mm)	0.38 (9.65)	0.38 (9.65)	0.50 (12.70)	0.50 (12.70)	0.75 (19.05)	1.25 (31.75)
Flexures	35,000	5,000	35,000	5,000	35,000	5,000

ELECTRICAL CHARACTERISTICS

Impedance (ohms)	50	50	50	50	50	50
Frequency Range (GHz)	DC-18	DC-40	DC-26.5	DC-26.5	DC-18	DC-18
Velocity of Propagation	83%	83%	83%	83%	83%	83%
Capacitance pf/ft (meter)	24.5 (80.4)	24.5 (80.4)	24.5 (80.4)	24.5 (80.4)	24.5 (80.4)	24.5 (80.4)
Shielding Effectiveness (dB @ 1 GHz)	> 100	> 100	> 100	> 100	> 100	> 100
Maximum Insertion Loss dB/ft (meter)	See figure on next page					
1 GHz	0.12 (0.39)	0.11 (0.36)	0.09 (0.30)	0.08 (0.26)	0.06 (0.20)	0.05 (0.16)
10 GHz	0.38 (1.25)	0.33 (1.08)	0.30 (0.98)	0.23 (0.76)	0.19 (0.62)	0.15 (0.49)
18 GHz	0.51 (1.67)	0.45 (1.48)	0.40 (1.31)	0.32 (1.05)	0.26 (0.85)	0.21 (0.69)
26.5 GHz	–	0.55 (1.81)	0.49 (1.61)	0.39 (1.28)	–	–
40 GHz	–	0.68 (2.23)	–	–	–	–
Phase Stability vs Flexure*						
10 GHz	1°	2°	1°	1°	3°**	3°**
18 GHz	1°	3°	1°	2°	5°**	5°**
Phase Stability vs Temperature	See figure on next page					
Power Handling	See figure on next page					
VSWR	Refer to Connector Selection Guide					

* Cable wrapped around a 2 inch diameter mandrel

** Cable wrapped around a 3 inch diameter mandrel

ENVIRONMENTAL CHARACTERISTICS

Temperature Range (Deg C)	-65/+165	-65/+165	-65/+165	-65/+165	-65/+165	- 65/+165
---------------------------	----------	----------	----------	----------	----------	-----------

See page 16 for applicable environmental test

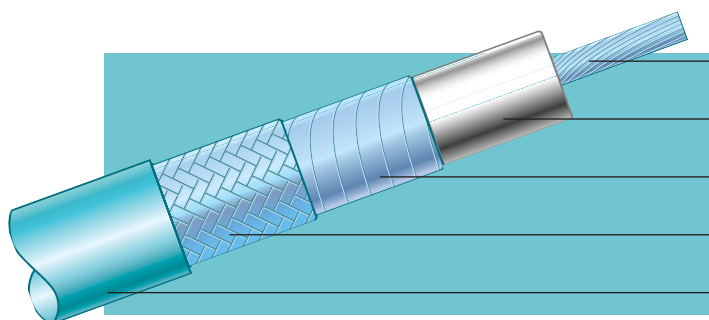

- Silver-Plated Copper Wire or Silver-Plated Copper Clad Steel Wire
- Ultra Low Density PTFE Dielectric
- Silver-Plated Copper Shield
- Silver-Plated Copper Braid
- FEP Jacket



Electrical Characteristics

MAXIMUM INSERTION LOSS

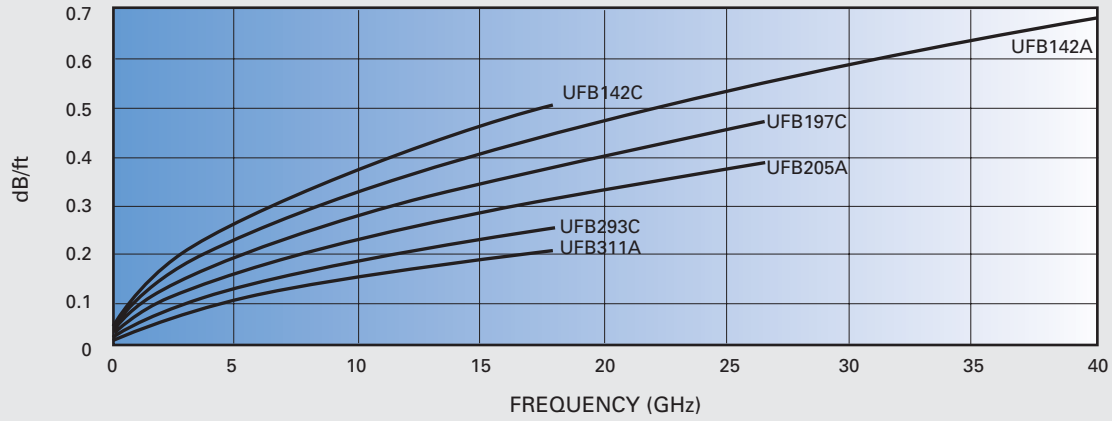

PHASE STABILITY VS. TEMPERATURE

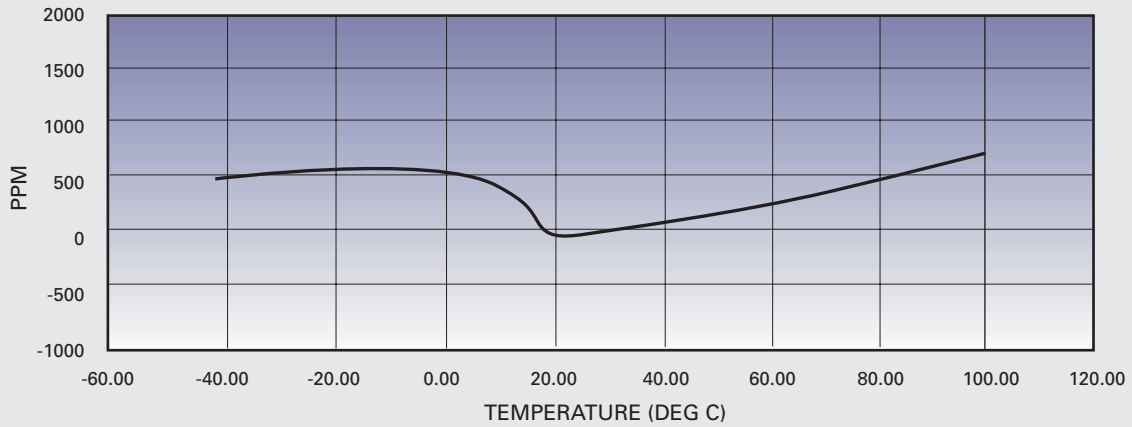

POWER HANDLING

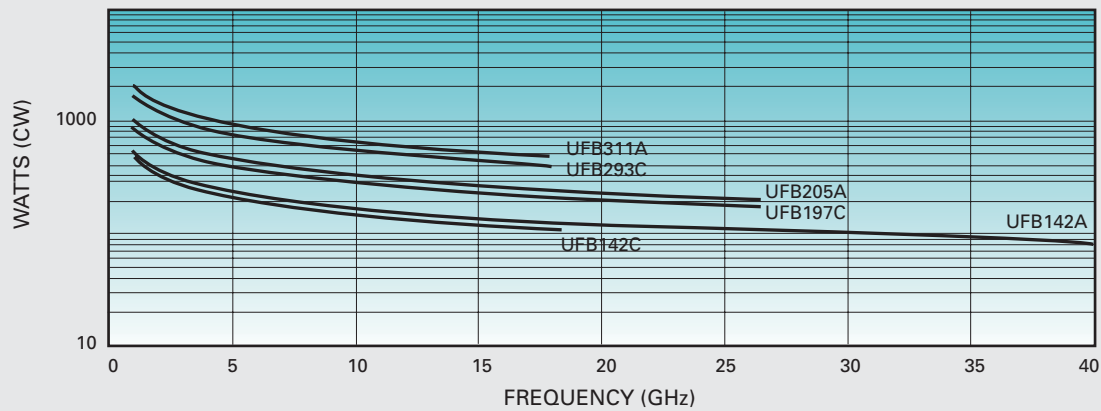



TiFLEX Ultralight Cable Assemblies

UTIFLEX Ultralight cable assemblies are optimized for spaceflight applications. They provide the lightest weight, lowest insertion loss, and best radiation resistance in a flexible cable construction. The cables utilize DuPont Aracon® for the outer shield, an ultra low density PTFE for the dielectric, and a Tefzel® jacket. If required, cable assemblies are manufactured in a Class 10,000 or Class 100 clean room by NASA Certified solder technicians.

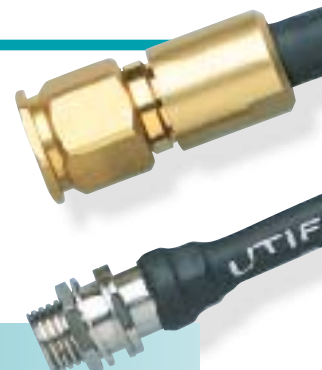

MECHANICAL CHARACTERISTICS

UTIFLEX TYPE	MCJ088D	MCJ142A	MCJ205A	MCJ311A
Outer Diameter inch (mm)	0.088 (2.24)	0.142	0.205 (5.21)	0.311 (7.90)
Center Conductor Type	Solid	Solid	Solid	Solid
Weight grams/ft (meter)*	3.3 (10.8)	7.0 (23.0)	15.0 (49.2)	33.0 (108.3)
Minimum Bend Radius inch (mm)	0.25 (6.35)	0.38 (9.65)	0.50 (12.70)	1.25 (31.75)
Flexures	5,000	5,000	5,000	5,000

ELECTRICAL CHARACTERISTICS

Impedance (ohms)	50	50	50	50
Frequency Range (GHz)	DC-18	DC-40	DC-26.5	DC-18
Velocity of Propagation	81%	83%	83%	83%
Capacitance pf/ft (meter)	25.6 (84.0)	24.5 (80.4)	24.5 (80.4)	24.5 (80.4)
Shielding Effectiveness (dB @ 1 GHz)	> 100	> 100	> 100	> 100
Maximum Insertion Loss dB/ft (meter)	See figure on next page			
1 GHz	0.21 (0.69)	0.11 (0.36)	0.08 (0.26)	0.05 (0.16)
10 GHz	0.67 (2.20)	0.33 (1.08)	0.23 (0.76)	0.16 (0.49)
18 GHz	0.90 (2.95)	0.45 (1.48)	0.32 (1.05)	0.21 (0.69)
26.5 GHz	–	0.55 (1.81)	0.39 (1.28)	–
40 GHz	–	0.68 (2.23)	–	–
Phase Stability vs Flexure*	10 GHz	1°	1°	3°**
18 GHz	2°	2°	2°	5°**
Phase Stability vs Temperature	See figure on next page			
Power Handling	See figure on next page			
VSWR	Refer to connector Selection Guide			

*Cable wrapped around a 2 inch diameter mandrel

**Cable wrapped around a 3 inch diameter mandrel

ENVIRONMENTAL CHARACTERISTICS

Temperature Range (Deg C)	-65/+165	-65/+165	-65/+165	-65/+165
Radiation (Mrads)	30	30	30	30
Outgassing (ASTM E-595)	<1% TML and <0.1% CVCM			

See page 16 for applicable environmental test

*Ultralight cables are also available with an aluminum center conductor which offers up to an additional weight savings of 10% depending on cable selected.

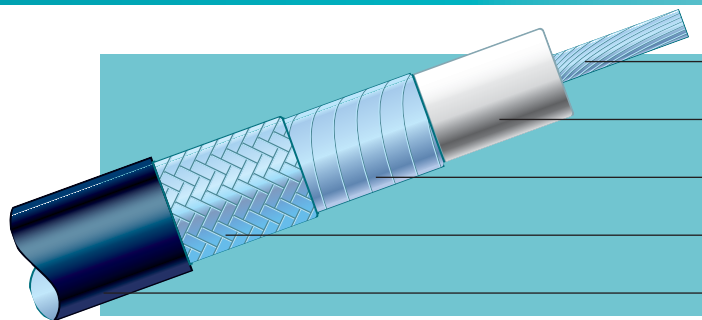

- Silver-Plated Copper Wire or Silver-Plated Copper Clad Steel Wire
- Ultra Low Density PTFE Dielectric
- Silver-Plated Copper Shield
- Silver-Plated Aracon® Braid
- Black Tefzel® Jacket



Electrical Characteristics

MAXIMUM INSERTION LOSS

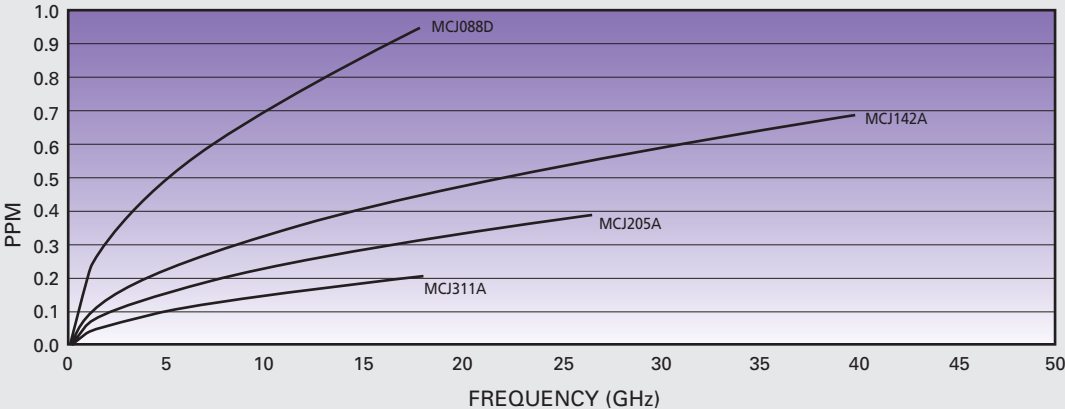

PHASE STABILITY VS. TEMPERATURE

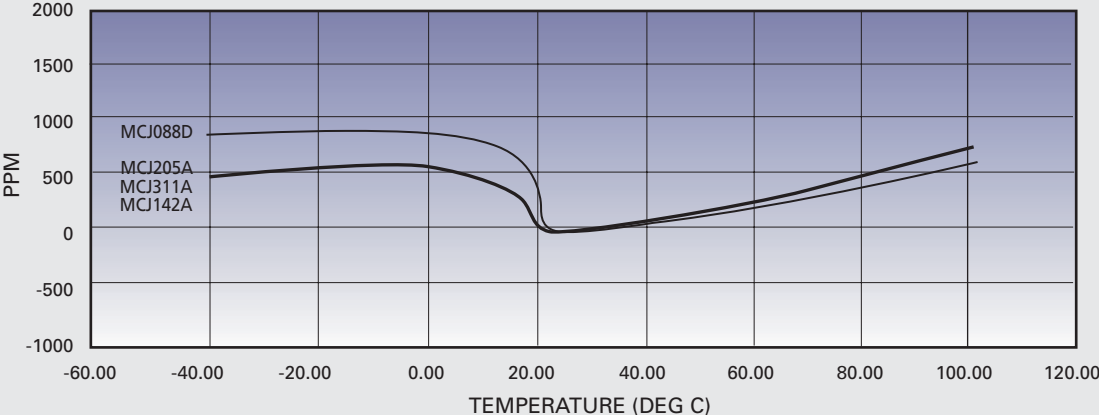

POWER HANDLING

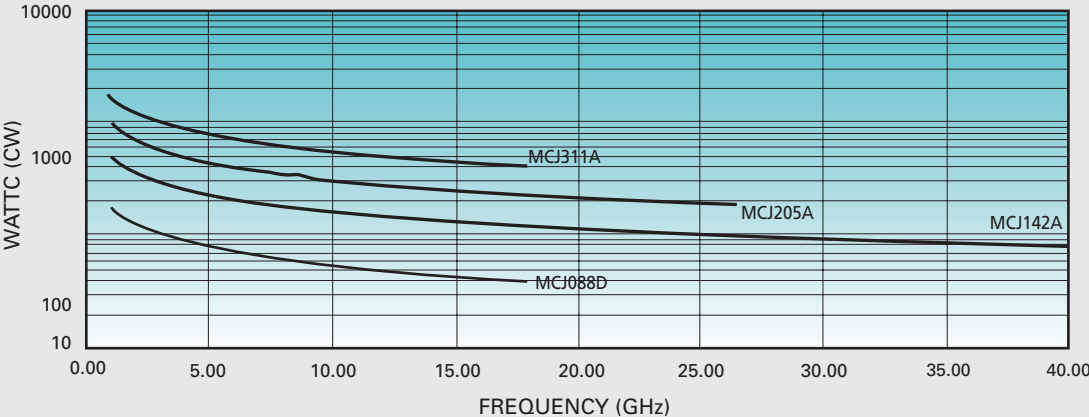

UTIFLEX cable assemblies are designed to survive the harshest and most stringent environments including:

- Spaceflight
- Arctic/Desert
- Airframe
- Battlefield
- Laboratory

UTIFLEX cable assemblies have tested successfully for numerous environmental requirements, some of which are listed below. After exposure to these conditions, the cable assembly did not show visible damage and the insertion loss, SWR, and connector interface dimensions remained within specified limits.

- Thermal Shock per MIL-STD-202, Method 107, 5 cycles, -55 to 165 degrees C, or MIL-STD-810, Method 503, Procedure I.
- Aging Stability per MIL-C-17, Paragraph 4.8.16, 165 degrees C for 168 hours.
- Vibration per MIL-STD-202, Method 204, Test Condition B.
- High Pressure, increase pressure at a rate of not more than 10 bar/minute to 100 ± 2 bar for 12 hours.
- Low Pressure per MIL-STD-1344A, Method 1004.
- Humidity per MIL-STD-810, Method 507, Procedure I.
- Salt Fog per MIL-STD-810, Method 509, Procedure I.
- Sand and Dust per MIL-STD-810, Method 510, Procedure I.
- Stress Crack Resistance per MIL-C-17, Paragraph 4.8.17.
- Cold Bend per MIL-C-17, Paragraph 4.8.19.
- Chemical Resistance
 - JP-4 and JP-5 fuels
 - Hydraulic fluid
 - Lubricating oil
 - Coolants of fluorocarbon, silicon, silicate ester, and glycol families
- Corrosive Atmosphere per MIL-E-5400, Paragraph 3.1.6.

MICRO-COAX in-house test capabilities include mechanical, visual, temperature, thermal shock, humidity, real-time x-ray, and a fully equipped microwave test lab for frequencies up to 65 GHz.

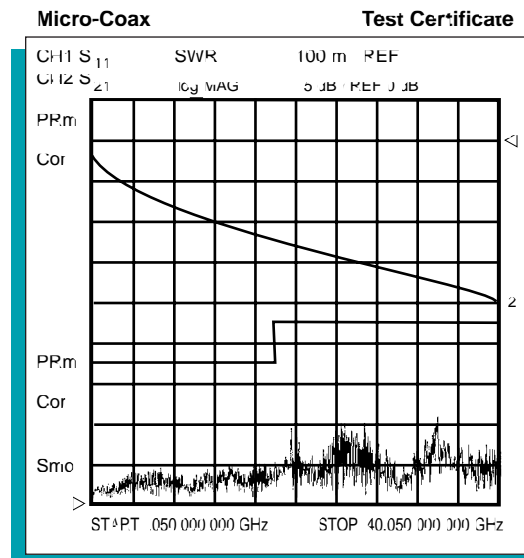

Part Number Designation

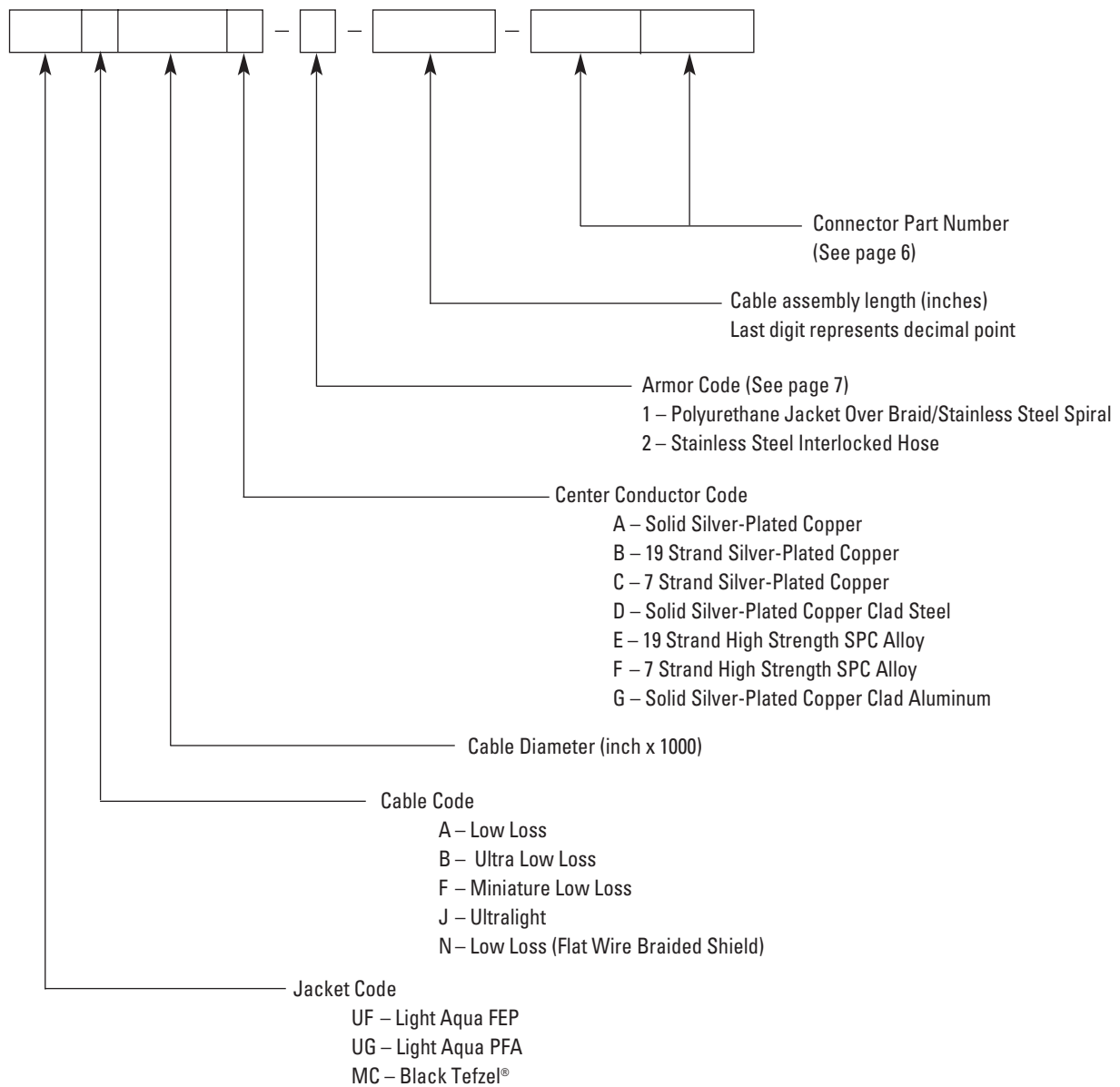

EXAMPLES

UFA210A-0-0360-300300
FEP jacketed, Low Loss, 0.210 inch diameter cable, solid silver-plated copper center conductor, no armor, 36.0 inches long, SMA plug connectors on each end.

UFB293C-2-0105-504310
FEP jacketed, Ultra Low Loss, 0.293 inch diameter cable, 7 strand silver-plated copper center conductor, stainless steel interlocked hose armor, 10.5 inches long, Precision N plug by SMA jack connectors.

Helpful Formulas

Characteristic Impedance

$$Z_0 = \frac{138}{\sqrt{e}} \log_{10} \frac{D}{d} \quad \dots \text{ohms}$$

Phase

$$\phi = \frac{30.5 \times F \times L \text{ (inches)}}{V_p} \quad \Delta\phi = \frac{\text{PPM} \times 30.5 \times F \times L \text{ (inches)}}{V_p \times 10^6}$$

Capacitance

$$C = \frac{7.38 e}{\log_{10} \frac{D}{d}} \quad \dots \text{pF/ft} \quad C = \frac{24.2 e}{\log_{10} \frac{D}{d}} \quad \dots \text{pF/m}$$

Delay

$$T = 1.016 \sqrt{e} \quad \dots \text{ns/ft} \quad T = 3.33 \sqrt{e} \quad \dots \text{ns/m}$$

$$L = \frac{0.984 T}{\sqrt{e}} \quad \dots \text{ft} \quad L = \frac{0.300 T}{\sqrt{e}} \quad \dots \text{m}$$

Velocity of Propagation

$$V_p = \frac{1}{\sqrt{e}} \times 100 \quad \dots \% \text{ of Free-Space Velocity}$$

Cutoff Frequency

$$F_{co} = \frac{7.5}{\sqrt{e} (D + d)} \quad \dots \text{GHz}$$

Attenuation (Theoretical) at 20° C

$$\alpha = \frac{0.434}{Z_0} \sqrt{F} \left(\frac{\sqrt{R_1}}{d} + \frac{\sqrt{R_2}}{D} \right) + 2.78 F \sqrt{e} P_f \quad \dots \text{dB/100 ft}$$

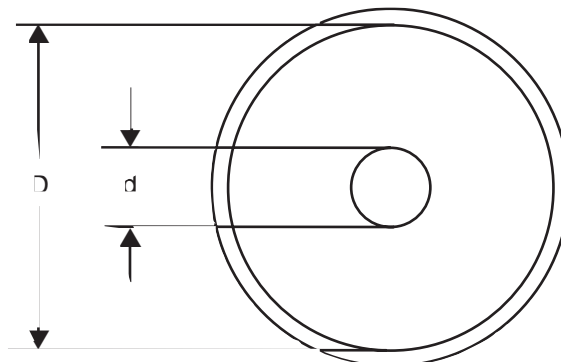

Symbols

e	Relative Dielectric Constant
Z ₀	Characteristic Impedance
D	Dielectric Diameter (inches)
d	Center Conductor Diameter (inches)
T	Time in Nanoseconds
L	Length
V _p	Velocity of Propagation
F _{co}	Cutoff Frequency
α	Attenuation
R ₁	Ratio of Center Cond. Conductivity to Copper
R ₂	Ratio of Outer Cond. Conductivity to Copper
P _f	Dielectric Power Factor
F	Frequency in GHz

Cable Assembly Care and Handling

Microwave cable assemblies are precision components that can be extremely fragile. Proper use, routine inspection, and cleaning of the connectors are required to maintain reliable performance.

Observe the minimum bend radius specified for the cable. Avoid pinching, crushing, twisting, or dropping the cable assemblies. Never pull

equipment using the cable assemblies. The assemblies are shipped in coils and must be carefully unrolled when ready for use.

Failure to follow these guidelines can damage the cable assembly. Even the smallest dent in the cable or lightest scratch on the connector interface can adversely affect the cable's performance.

Applications Engineering

Our Applications Engineering staff is available for technical support in the design, utilization, testing, and production of any UTIFLEX cable assembly.

Prototype Capability

Samples can be manufactured for specific applications and supplied to you promptly. If new connector or cable designs are required, our experienced staff can offer a quick turnaround.

Qualification Testing

MICRO-COAX can economically perform all qualification testing including writing of required test procedures.

Program Management

MICRO-COAX has participated in many large military and commercial programs. We maintain complete program management capability necessary to successfully complete development and production of any size project.

Warranty

All UTIFLEX cable assemblies have a limited one year warranty subject to MICRO-COAX review.

How to Order

Please order by UTIFLEX part number (see page 17) and/or drawing number, adding any special requirements. Your order should include the length required, connector type, and frequency range.

Where to Order

In U.S.A.:

MICRO-COAX
206 Jones Boulevard
Pottstown, PA 19464-3465

Phone: 610-495-0110
Fax: 610-495-6656
E-mail: sales@micro-coax.com
www.micro-coax.com

In Europe:

ROSENBERGER MICRO-COAX
2B Mercury House, Calleva Park
Aldermaston, Berkshire RG7 8PN
England

Phone: 44-1189-810023
Fax: 44-1189-816180

Terms

Formal price quotations remain in effect for 30 days unless otherwise specified on quotation. Terms of payment are Net 30 days, subject to credit approval.

Shipments

Unless specific instructions accompany the order, shipment is made FOB Pottstown, PA. MICRO-COAX will use its judgment as to the best method of shipment. MICRO-COAX reserves the right to ship COD or upon receipt of advance payment. All claims of shortages must be made within 10 days of receipt of material.

Return Policy

Please contact MICRO-COAX for an RMA number before returning product. The RMA should be referenced on the packing container and all associated paperwork.

Additional Information

Please visit our web site at www.micro-coax.com.



TiFLEX Request for Quote Form

Please fill in your requirements below. Complete only those items necessary for your application and FAX TO:
MICRO-COAX 610-495-6656.

Information

Company _____ Program _____
Name _____ Phone _____
Initial Quantity Required _____ Fax _____
Additional Quantities _____ Required Delivery _____
Other Comments _____

Electrical Requirements

Frequency Range _____ Maximum SWR _____
Insertion Loss _____
Power Handling _____ Watts (CW) _____ Watts (Peak)
Other Requirements _____

Mechanical Requirements

Connector Type (1) _____ Connector Type (2) _____
Length _____ Maximum Cable Outer Diameter _____
Maximum Cable Assembly Weight _____ Minimum Bend Radius of Cable _____
Other Requirements _____

Environmental Requirements

Temperature _____ Altitude _____
Vibration _____ Shock _____
Other Special Environmental Needs _____

Semi-rigid Cables and Assemblies

- 74 standard semi-rigid cables in stock
- 25 MIL-C-17 QPL models
- Impedance from 5 to 125 ohms, sizes from 0.008 to 0.750 in.
- 100% RF shielding
- Low VSWR
- Many material options
- Low loss cables available. These employ a low-density PTFE dielectric for better phase stability and no thermal expansion of dielectric resulting in greater power handling ability and broader operating temperature range than standard MIL-C-17 cables

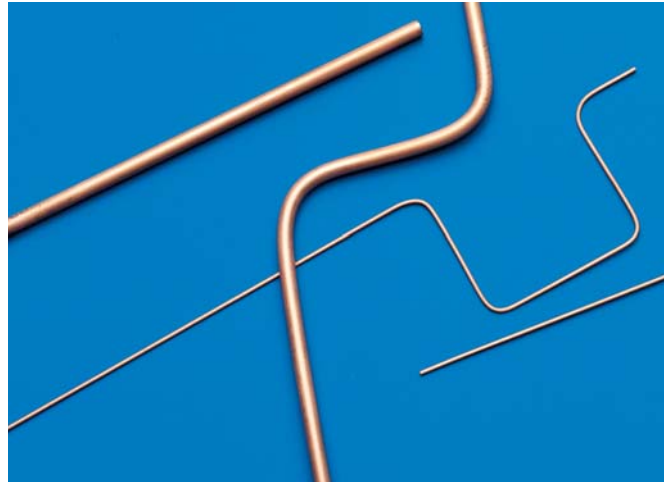

Coaxial Delay Lines

- Extremely reliable way to generate short delays needed by base station amplifiers, radar, ECM, instrumentation, and many other applications
- Standard delays from 5 to 200 ns
- Wide choice of custom configurations
- Low loss cables as described above offer excellent phase stability and a high volume solution for feed forward amplifiers





MICRO-COAX[®]

Leading the way in transmission line solutions.

206 Jones Boulevard, Pottstown, PA 19464-3465

Telephone: 610-495-0110 • Fax: 610-495-6656

In Europe call: (44) 1189-810023 • Fax: (44) 1189-816180

www.micro-coax.com

11/03 LA 5K