

REVISIONS				
REV	DESCRIPTION	DATE	DWN	APP
A	ECO 45114	6/29/04	HJF	MKG

Micro-Coax Specification

Cable Assemblies, UFA147B

Low Loss, 26.5 GHz

Copyright Micro-Coax, Inc.

<p>THIS SPECIFICATION IS THE PROPERTY OF MICRO-COAX, INC. AND MAY NOT BE USED OR COPIED WITHOUT THE EXPRESS WRITTEN PERMISSION OF MICRO-COAX, INC.</p>	APPROVALS	DATE	FSCM NO. 64639	 <i>Leading the way in transmission line solutions.</i>		
	DWN HJF	3/8/04				
	CHK DMD	6/1/04				
	ENGR HJF	3/8/04	TITLE MICRO-COAX SPECIFICATON CABLE ASSEMBLIES, UFA147B LOW LOSS, 26.5 GHz			
	QA MKG	6/29/04				
	PLM RAS	6/29/04	PART NO.	DWG. NO.	REV.	
CUST		70916	A-16048	A		
		SCALE	None	DWG. SIZE:	A	PAGE 1 OF 24

1. SCOPE

Detail specifications for low loss microwave cable assemblies incorporating Micro-Coax UFA147B cable. Cable assemblies per this specification are intended for high reliability applications.

2. APPLICABLE DOCUMENTS

The following documents form a part of this specification to the extent specified herein. In the event of conflict, this specification shall govern.

2.1 SPECIFICATIONS

MIL-C-17	Cables, Radio Frequency, Flexible and Semi-Rigid, General Specification For
MIL-PRF-39012	Connectors, Coaxial, Radio Frequency, General Specification For
MIL-G-45204	Gold Plating, Electrodeposited
MIL-I-23053	Insulation Sleeving, Electrical, Heat Shrinkable, General Specification For
MIL-M-81531	Marking of Electrical Insulation Materials
MIL-P-46179	Plastic Molding and Extrusion Material, Polyamide Imide (PAI)
MIL-R-46198	Resin, Polyamide, Hot Pressed or Pressed and Sintered.

2.2 MILITARY STANDARDS

MIL-STD-202	Test Methods for Electronic and Electrical Components Parts
MIL-STD-810	Test Method Standard for Environmental Engineering Considerations and Laboratory Tests
MIL-STD-1344	Test Method for Electrical Connectors

2.3 OTHER

ASTM A-582	Standard Specification for Free Machining Stainless and Heat Resisting Steel Bars
ASTM A-967	Standard Specification for Chemical Passivation Treatments for Stainless Steel Parts
ASTM B-16	Standard Specification for Rod, Brass, Free Cutting, Bar and Shapes for Use in Screw Machines
ASTM B-36	Standard Specification for Plate, Brass, Sheet, Strip, and Rolled Bar
ASTM B-196	Standard Specification for Rod and Bar Beryllium Copper Alloy
ASTM B-197	Standard Specification for Wire, Alloy Copper Beryllium
ASTM B-298	Standard Specification for Silver-Coated Soft or Annealed Copper Wire

2.3 OTHER (Cont'd)

ASTM D-1418	Standard Practice for Rubber and Rubber Lattices
ASTM D-1457	Standard Practice for Polytetrafluoroethylene (PTFE) Molding and Extrusion materials
ASTM D-4067	Standard Specification for Reinforced and Filled Polyphenylene Sulfide (PPS) Injection Molding and Extrusion Materials
ASTM D-5205-	Standard Classification System for Polyetherimide (PEI) Materials
ANSI/IPC-J-STD-001	Requirements for Soldered Electrical and Electronic Assemblies
QQ-N-290	Nickel Plating (Electrodeposited)
A-14342	Micro-Coax Control Specification For Electrodeposited Coatings

3. REQUIREMENTS

3.1 GENERAL

Cable assemblies procured to this specification shall be in accordance with the requirements specified herein.

3.2 NOTIFICATION OF CHANGE

The release of this specification is uncontrolled. Micro-Coax, Inc. reserves the right to make changes without notification.

3.3 LOT CONTROL

Records that are traceable to the specific raw materials relating to the finished cable assembly shall be retained for a minimum of seven years.

3.4 MATERIALS

3.4.1 Cable Center Conductor

19-strand silver plated copper per ASTM B-298. Silver plating thickness shall be 40 micro-inches minimum.

3.4.2 Cable Dielectric

Low density PTFE in accordance with the applicable paragraph of MIL-C-17.

MICRO-COAX [®] <i>Leading the way in transmission line solutions.</i>	FSCM NO. 64639	DWG. NO. A-16048	REV. A
	SCALE NONE	DWG SIZE A	PAGE 3 OF 25

- 3.4.3 **Cable Inner Shield**
Silver plated copper foil per ASTM B-298. Silver plating thickness shall be 40 micro-inches minimum.
- 3.4.4 **Cable Outer Shield**
Silver plated copper wire per ASTM B-298. Silver plating thickness shall be 40 micro-inches minimum.
- 3.4.5 **Cable Jacket**
Fluorinated Ethylene Propylene (FEP) in accordance with MIL-C-17, Type IX, except not transparent.

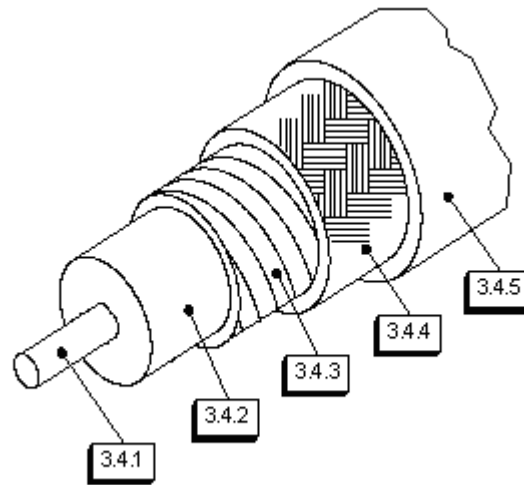



Fig. 1 UFA147B Cable Construction

- 3.4.6 **Heat Shrinkable Marking Material**
Polyolefin per MIL-I-23053.
- 3.4.7 **Marking Ink**
Shall meet the permanency requirements of MIL-M-81531.
- 3.4.8 **Heat Shrinkable Bend Restrictors**
Adhesive lined Polyolefin per MIL-I-23053
- 3.4.9 **Polyurethane over Stainless Steel Spiral Armoring Designated -1 (if specified)**
Polyurethane to be in accordance with MIL-C-17, Type XII. Stainless Steel spiral to be Type 302. Braid interlayer to be silver plated copper per ASTM B-298.
- 3.4.10 **Interlocked Metal Hose Armoring Designated -2 (if specified)**
Stainless steel to be Type 304.

 <i>Leading the way in transmission line solutions.</i>	FSCM NO. 64639	DWG. NO. A-16048	REV. A
	SCALE NONE	DWG SIZE A	PAGE 4 OF 25

3.4.11 FEP over Stainless Steel Spiral Low Outgassing Armoring Designated –Q (if specified)

FEP shall be in accordance with MIL-C-17, Type IX. Stainless steel to be Type 302. Braid interlayer to be silver plated copper per ASTM B-298.

3.4.12 Connectors

Shall be as specified on the order. Materials shall be as detailed herein unless otherwise detailed on the Micro-Coax connector specification drawing (contact factory for a copy).

3.4.12.1 Connector Body

Beryllium copper per ASTM B-196, Temper TD04 (H) or TH04 (HT), UNS No. C17300 or non-magnetic corrosion resistant steel (CRES) per ASTM A-582, UNS No. S30300, passivated per ASTM A-967. Plating (when required) shall be gold per MIL-G-45204, Type II, Grade C, Class 1, 50 micro-inches minimum thickness over nickel underplate per QQ-N-290, Class 1, 50 micro-inches minimum thickness.

3.4.12.2 Connector Coupling Nut

Non-magnetic corrosion resistant steel (CRES) per ASTM A-582, UNS No. S30300, passivated per ASTM A-967.

3.4.12.3 Connector Clamp Nut

Non-magnetic corrosion resistant steel (CRES) per ASTM A-582, UNS No. S30300, passivated per ASTM A-967.

3.4.12.4 Connector Cap

Convex caps to be copper alloy per ASTM B-36, UNS No. C26000, temper H02, gold plated per MIL-G-45204, Type II, Grade C, Class 1, 50 micro-inches minimum thickness over nickel underplate per QQ-N-290, Class 1, 50 micro-inches minimum thickness. Knurled caps to be copper alloy per ASTM B-16, UNS No. C36000, temper H02, gold plated per MIL-G-45204, Type II, Grade C, Class 1, 50 micro-inches minimum thickness over nickel underplate per QQ-N-290, Class 1, 50 micro-inches minimum thickness.

3.4.12.5 Connector C Ring

Beryllium copper per ASTM B-197, Temper TH04 (HT), Alloy C17200.

3.4.12.6 Connector Center Contact

Beryllium copper per ASTM B-196, UNS No. C17300, Temper TD04 (H) or TH04 (HT), gold plated per MIL-G-45204, Type II, Grade C, Class 1, 50 micro-inches minimum thickness over nickel underplate per QQ-N-290, Class 1, 50 micro-inches minimum thickness.

MICRO-COAX [®] <i>Leading the way in transmission line solutions.</i>	FSCM NO. 64639	DWG. NO. A-16048	REV. A
	SCALE NONE	DWG SIZE A	PAGE 5 OF 25

3.4.12.7 Connector Dielectric Support Beads

Shall consist of one or more of the following materials as detailed on the connector specification sheet.

- a) Polyetherimide thermoplastic, unreinforced, PEI0113 (Ultem 1000) per ASTM D-5205.
- b) Polyimide (Vespel SP-1) per MIL-R-46198, Type 1.
- c) TFE per ASTM D-1457, Type 1, Grade 1, Class B.
- d) Polyamide Imide, PAI (Torlon) per MIL-P-46179, Type 1.
- e) Polyphenylene Sulfide (PPS) per ASTM D-4067

3.4.12.8 Connector Gaskets and O Rings

Fluorocarbon elastomer (Viton) per ASTM D-1418, Grade 55-65, or silicone rubber per ZZ-R-765, Class IIB, Grade 65-75.

3.5 CONSTRUCTION

3.5.1 Cable Dielectric and Center Conductor

Shall consist of a dielectric around a 19-strand center conductor. Statistical Process Control (SPC) shall be used to monitor the core diameter during extrusion.

3.5.2 Cable Inner Shield

Shall be a 0.002 x 0.090 inch (0.051 x 2.286 mm) foil wrapped tightly over the dielectric. A constant minimum tension shall be maintained during the wrapping process. There shall be a minimum of 40% overlap between each layer of foil. Statistical Process Control (SPC) shall be used to monitor the foil diameter during application.

3.5.3 Cable Outer Shield

Shall be tightly wound braid over the inner shield. A constant minimum tension shall be maintained during the braiding process.

3.5.4 Cable Jacket

Shall be a continuous extrusion over the outer shield. There shall be a minimum adhesion of 2 pounds per six-inch length between the jacket and outer shield. Statistical Process Control (SPC) shall be used to monitor the cable diameter as the jacket is being applied.

3.5.5 Heat Shrinkable Markers

Shall be shrunk over the bend restrictors with a minimum temperature of 135° C. The markers shall adhere to the cable and shall not be able to be moved relative to the cable.

3.5.6 Heat Shrinkable Bend Restrictors

Shall be shrunk over the connector to cable transition area with a minimum temperature of 135° C. The bend restrictor shall adhere to the cable and shall not be able to be moved relative to the cable.

 <i>Leading the way in transmission line solutions.</i>	FSCM NO. 64639	DWG. NO. A-16048	REV. A
	SCALE NONE	DWG SIZE A	PAGE 6 OF 25

3.5.7 Armoring (if specified)

The cable shall be loaded into the armoring prior to connector installation. During connector installation, the armoring shall be mechanically attached to the rear of the connector. The attachment shall be able to withstand a minimum pull force of 10 pounds (44.5 N).

3.5.8 Connectors

Connectors shall be as specified and conform to the requirements of MIL-PRF-39012 as applicable. All PTFE connector parts shall be conditioned for a minimum of one hour at 125° C prior to assembly. All center contacts shall be captivated to withstand a minimum of 6 pounds (26.7 N) of axial force.

MICRO-COAX [®] <i>Leading the way in transmission line solutions.</i>	FSCM NO. 64639	DWG. NO. A-16048	REV. A
	SCALE NONE	DWG SIZE A	PAGE 7 OF 25

3.5.9 Soldering

All solder shall be Type SN63 or SN96 per ANSI/IPC-J-STD-001 as the application requires. When required, the cable center conductor and outer shield shall be pre-tinned.

3.6 MECHANICALS

3.6.1 Cable Dimensions

Cable dimensions shall be as specified in Table 1 below:

Center Conductor Diameter	0.0376 inch	0.96 mm
Dielectric Diameter	0.106 inch	2.69 mm
Inner Shield Diameter	0.112 Inch	2.86 mm
Outer Shield	0.129 inch	3.28 mm
Jacket Diameter	0.147 ± 0.005 inch	3.73 ± 0.13 mm
Jacket Wall Thickness	>0.009 inch	>0.22 mm

Table 1 UFA147B Cable Dimensions

3.6.2 Connector Dimensions

Outline dimensions are detailed in the Micro-Coax connector specification drawings (contact factory for a copy). Interface dimensions shall be per the applicable industry or military standard.

3.6.3 Cable Jacket Color

Light aqua.

3.6.4 Marker Color

Aqua.

3.6.5 Cable Minimum Static Bend Radius :0.25 inch (6.35 mm)

The cable impedance shall not change by more than 0.5 ohm when wrapped (360°) around a 0.50 inch (12.70 mm) diameter mandrel.

3.6.6 Cable Minimum Dynamic Bend Radius : 1.5 inch (38.4 mm)

The cable shall withstand 10,000 flexes of ± 90° around a three-inch (76.20 mm) diameter mandrel (tic-toc test) with minimal performance degradation.

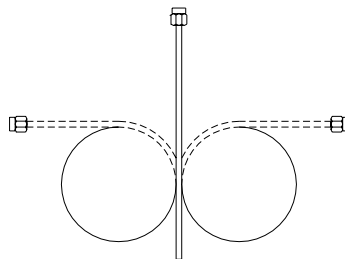

Fig 2. Cable Dynamic Bend Radius

3.6.7 Cable Flex Life

The cable shall withstand 100,000 unrestrained flexes (snake test) with minimal degradation.

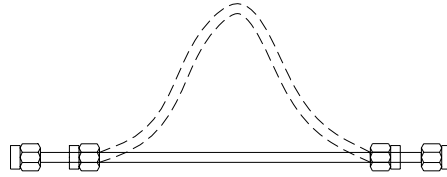

Fig 3. Cable Flex Life

3.6.8 Cable Weight

11 grams per foot (36.1 grams per meter, 0.025 lbs. per foot) nominal.

3.6.9 Cable Dimensional Stability : 0.25 inches (6.35 mm)

After 40 thermal shocks of -65° C to +125° C, the unrestricted cable layers shall have less than 0.25 inch (6.35 mm) movement relative to the center conductor.

3.6.10 Cable Compression Resistance ; 50 lbs. (222.4 N)

The cable shall withstand a compressive load of 50 pounds (222.4 N) over a cable length of 3 inches (76.2 mm) with minimal performance degradation.

3.6.11 Connector Retention

The connectors shall withstand an axial pull force of 25 pounds (111.2 N) with minimal degradation.

3.6.12 Connector Plating Adhesion

The connectors shall withstand the plating adhesion test in accordance with Micro-Coax specification A-14342, paragraphs 6.3 (Peel Test) and 6.5 (Crush Test).

3.6.13 Coupling Mechanism Proof Torque

The coupling mechanism of all threaded connector coupling nuts shall not be dislodged from the connector body when the specified force is applied. Refer to individual connector specifications for details. The mechanism will rotate freely. The interface dimensions of the socket connector shall not cause destructive mating.

3.6.14 Cable Assembly Length

The length shall be as specified on the order. The tolerance for non-phase matched assemblies, unless otherwise specified, shall be the greater of +0.5/-0.0 inch (+12.7/-0.0 mm) or +0.5/0.0%.

 <i>Leading the way in transmission line solutions.</i>	FSCM NO. 64639	DWG. NO. A-16048	REV. A
	SCALE NONE	DWG SIZE A	PAGE 9 OF 25

3.6.15 Cable Assembly Marking

Unless otherwise specified, each cable assembly shall have two markers.

Marker 1 shall read: *MICRO-COAX*
UTiFLEX

Marker 2 shall read*: UFA147B-X-YYYY-ZZZAAA
FSCM 64639 SN MMDD

*Where X indicates the armor type, YYYY is the length in inches plus one decimal point, ZZZAAA are the connector codes, and MMDD is the serial number.

3.7 ELECTRICALS SPECIFICATIONS

3.7.1 Frequency Range

Shall be DC-26.5 GHz for the cable, however, some connectors may result in a lower frequency range for the cable assembly. Maximum frequency ranges are detailed in the Micro-Coax connector specification drawings (contact factory for a copy).

3.7.2 Insertion Loss

3.7.2.1 Maximum Insertion Loss

The maximum insertion loss shall be as shown in Figure 4 below:

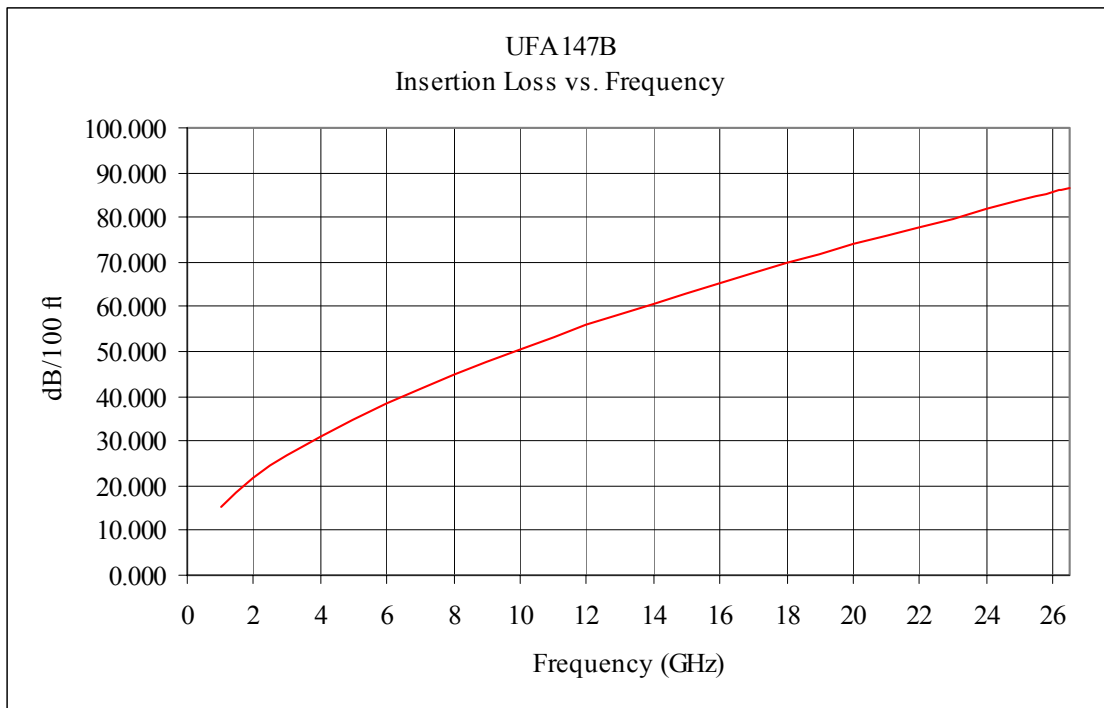

Fig. 4 UFA147B Maximum Insertion Loss

MICRO-COAX [®] <i>Leading the way in transmission line solutions.</i>	FSCM NO. 64639	DWG. NO. A-16048	REV. A
	SCALE NONE	DWG SIZE A	PAGE 10 OF 25

3.7.2.1 Maximum Insertion Loss (Cont'd)

The insertion loss graphical display (trace) shall be a smooth continuous curve with a maximum ripple of ± 0.1 dB. Maximum cable assembly insertion loss can be calculated using the following equation:

$$IL = L*(0.148\sqrt{F} + 0.004F) + C_1\sqrt{F} + C_2\sqrt{F}$$

Where L = Length in feet
 F = Frequency in GHz
 C₁ = Connector 1 constant*
 C₂ = Connector 2 constant*

*The connector constants are generally 0.03 for straight and 0.06 for right angle connectors.

The maximum insertion loss for various lengths of cable assemblies is listed in Table 2 below. All connectors are assumed to be straight. Typical values will be approximately 5% lower.

1	0.21	0.36	0.51	0.82	1.57	3.85	7.63
2	0.30	0.52	0.73	1.17	2.25	5.50	10.91
3	0.37	0.64	0.91	1.44	2.78	6.79	13.47
4	0.43	0.74	1.05	1.67	3.23	7.89	15.66
5	0.48	0.83	1.18	1.88	3.63	8.88	17.62
6	0.53	0.92	1.30	2.07	4.00	9.77	19.40
7	0.58	0.99	1.41	2.25	4.34	10.61	21.06
8	0.62	1.07	1.52	2.41	4.66	11.39	22.62
9	0.66	1.14	1.61	2.57	4.96	12.14	24.09
10	0.70	1.20	1.71	2.72	5.25	12.84	25.50
11	0.73	1.26	1.80	2.86	5.53	13.52	26.84
12	0.77	1.33	1.88	3.00	5.79	14.17	28.14
13	0.80	1.38	1.97	3.13	6.05	14.80	29.39
14	0.83	1.44	2.05	3.26	6.30	15.41	30.60
15	0.86	1.49	2.12	3.39	6.54	16.00	31.77
16	0.89	1.55	2.20	3.51	6.78	16.58	32.92
17	0.92	1.60	2.27	3.63	7.00	17.14	34.03
18	0.95	1.65	2.35	3.74	7.23	17.69	35.12
19	0.98	1.70	2.42	3.85	7.45	18.22	36.18
20	1.01	1.75	2.49	3.96	7.66	18.74	37.22
21	1.03	1.79	2.55	4.07	7.87	19.26	38.24
22	1.06	1.84	2.62	4.18	8.07	19.76	39.24
23	1.09	1.89	2.68	4.28	8.27	20.26	40.22
24	1.11	1.93	2.75	4.38	8.47	20.74	41.19
25	1.14	1.97	2.81	4.48	8.67	21.22	42.14
26	1.16	2.02	2.87	4.58	8.86	21.69	43.07
26.5	1.17	2.04	2.90	4.63	8.95	21.92	43.53

Table 2 UFA147B Insertion Loss vs. Length

 <i>Leading the way in transmission line solutions.</i>	FSCM NO. 64639		DWG. NO. A-16048		REV. A
	SCALE	NONE	DWG SIZE	A	PAGE 11 OF 25

3.7.2.2 Insertion Loss Stability versus Temperature

The insertion loss change with temperature shall be as shown in Figure 5 below:

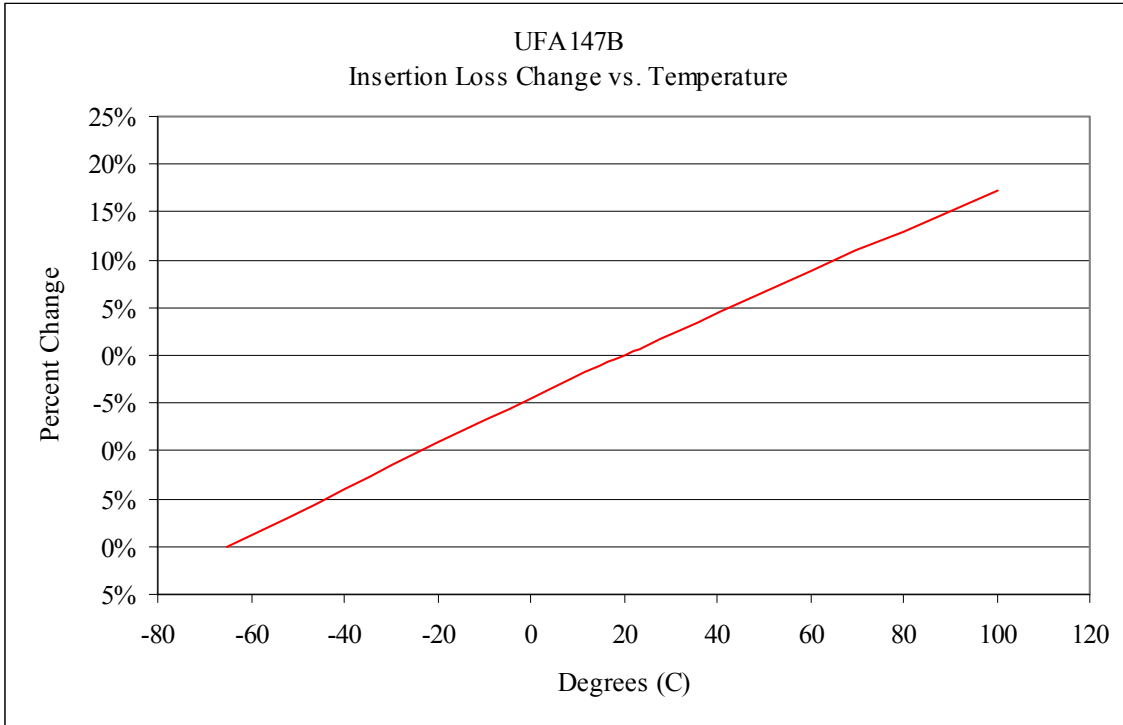

Fig. 5 UFA147B Maximum Insertion Loss Change vs. Temperature

3.7.3 SWR (Return Loss)

SWR is primarily a function of the connectors. The maximum cable assembly SWR can be calculated using the following equation:

$$\text{Maximum SWR} = C_{1\text{SWR}} \times C_{2\text{SWR}}$$

Where $C_{1\text{SWR}}$ = SWR of connector 1
 $C_{2\text{SWR}}$ = SWR of connector 2

$C_{1\text{SWR}}$ and $C_{2\text{SWR}}$ for each connector can be found in the Micro-Coax connector specification drawings (contact factory for a copy).

3.7.4 Impedance

50 ohms nominal.

3.7.5 Capacitance

26.2 pF/ft (86.0 pF/m) nominal.

 <i>Leading the way in transmission line solutions.</i>	FSCM NO. 64639	DWG. NO. A-16048	REV. A
	SCALE NONE	DWG SIZE A	PAGE 12 OF 25

3.7.6 Velocity of Propagation (Time Delay)

77% of the speed light, which equates to a time delay of 1.25 ns/ft (4.10 ns/m).

3.7.7 Electrical Phase

3.7.7.1 Phase Matching

Unless specified on the order, cable assemblies will not be phase matched. If phase matching is required, one of the following options must be detailed on the order.

3.7.7.1.1 Absolute Phase Matching

Consists of matching two or more assemblies to an absolute electrical length plus a tolerance. Generally, the absolute length is specified as an equivalent air-line length in inches or centimeters derived from actual measurements. Specifying the absolute length in this manner simplifies the measurement on modern vector network analyzers. In addition, it is often easier to specify the equivalent airline length after the first lot of cable assemblies have been manufactured, resulting in tighter mechanical length tolerances. Although tighter tolerances can be achieved, the default phase matching tolerance shall be 0.5°/GHz.

3.7.7.1.2 Relative Phase Matching

Consists of matching two or more assemblies relative to each other, not to an absolute length. Each assembly in a particular set will meet the matching criteria, however, it is unlikely that succeeding sets will match each other. As a result, assemblies that are ordered with relative phase matching should be ordered as sets. If one assembly within a set needs to be replaced, an entire new set must be ordered. Although tighter tolerances can be achieved, the default phase matching tolerance shall be 0.5°/GHz.

 <i>Leading the way in transmission line solutions.</i>	FSCM NO. 64639	DWG. NO. A-16048	REV. A
	SCALE NONE	DWG SIZE A	PAGE 13 OF 25

3.7.7.1.3 Phase Change versus Bending

The expected phase change when the cable is wrapped one time (360°) around a three inch mandrel is shown in Figure 6 below:

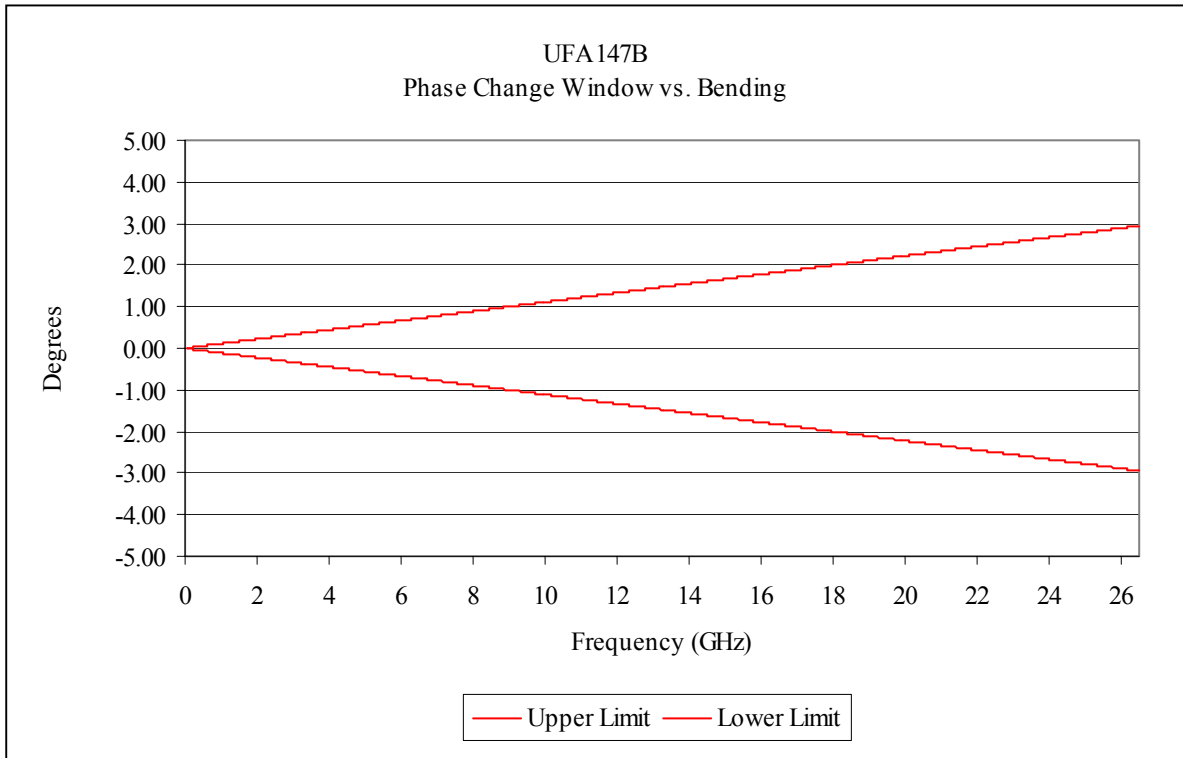

Fig 6 UFA147B Phase Change vs. Bending

3.7.7.2 Phase Stability versus Temperature

Shall be as shown in Figure 7 below. The phase stability versus temperature may differ from the figure depending on the length of the cable assembly and the type of connectors.

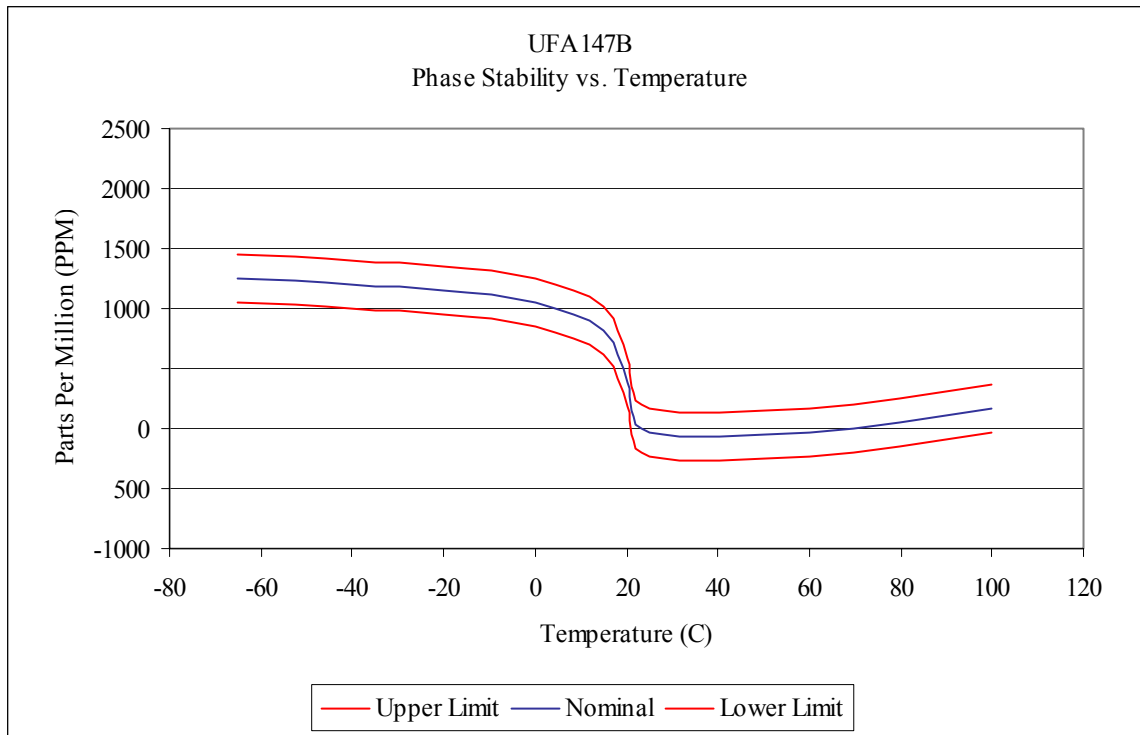

Fig. 7 UFA147B Phase Change vs. Temperature

3.7.7.3 Phase Tracking

Phase tracking defines the difference in phase change between like cable assemblies with changing temperature. Cable assemblies of equal length and connectors made from the same cable manufacturing lot shall phase track within 200 PPM of each other.

3.7.8 RF Shielding

Shall be -90 dB minimum from 1 to 26.5 GHz. However, cable assembly shielding effectiveness can be limited by the connector design.

3.7.9 Passive Intermodulation (PIM)

PIM requirements must be specified. Standard cable assemblies are not rated for PIM. For low PIM requirements, Micro-Coax employs special connectors and assembly processes.

3.7.10 Corona Extinction (cable only)

2000 VRMS minimum at 60 Hz. Maximum operating voltage may be limited by the connector type, as detailed in the Micro-Coax connector specification drawings (contact factory for a copy).

3.7.11 Dielectric Withstanding Voltage (cable only)

5000 VRMS minimum at 60 Hz.

3.7.12 Power

The average continuous wave (CW) power handling capability for the cable shall be as shown in Figure 8 below. Cable assembly power ratings may be limited by the connector type.

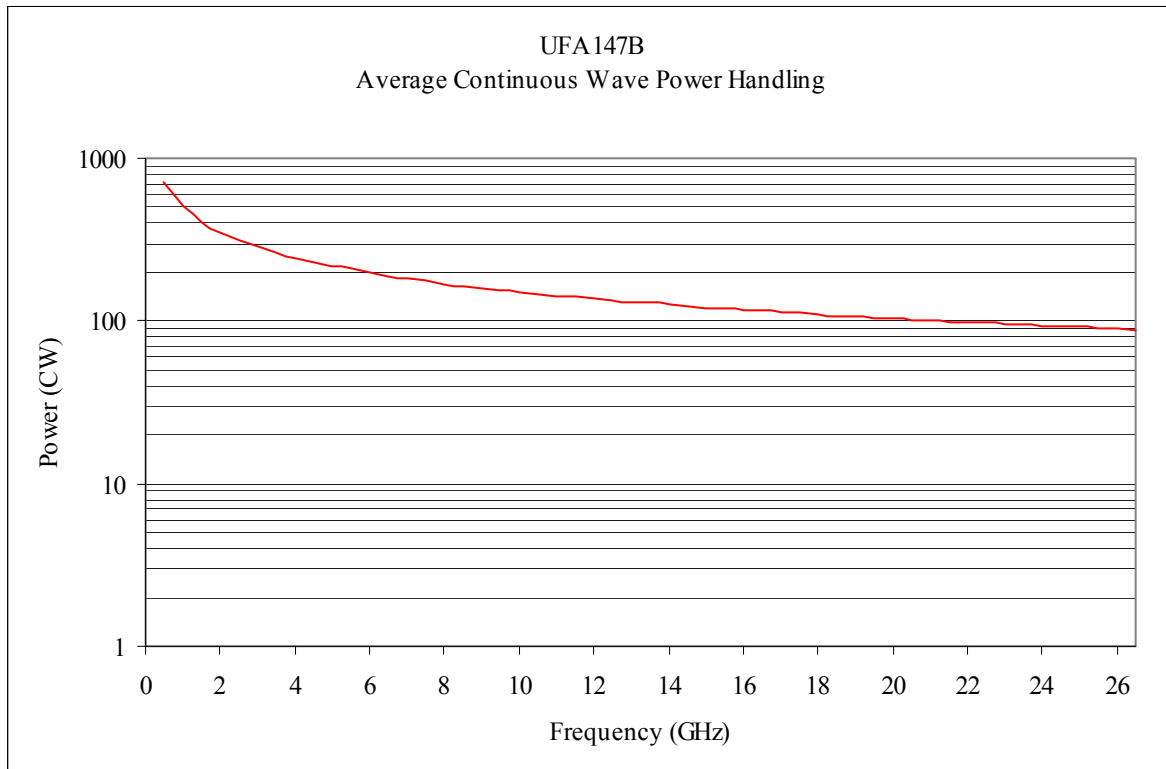

Fig. 8 UFA147B Power

3.7.13 Jacket Spark Test

Cable jacket shall withstand 3000 VRMS without breakdown, flashover, or spark over.

3.8 ENVIRONMENTALS CHARACTERISTICS

3.8.1 Thermal Shock

Cable shall be capable of withstanding 40 thermal shocks from -65° to +125° C with minimal degradation to the cable performance.

3.8.2 Cold Bend

Cable, when wrapped 10 times around a 0.5 inch (12.7 mm) mandrel and conditioned at -40° C for 20 hours minimum, shall show no evidence of cracks, flaws, or other damage in the jacket material.

3.8.3 Stress Crack Resistance

Cable, when wrapped 10 times around a 0.5 inch (12.7 mm) mandrel and conditioned at 230° C for 96 hours minimum, shall show no evidence of cracks, flaws, or other damage in the jacket material.

3.8.4 Vibration Stability (Shake Test)

The cable phase and insertion loss change, while being vibrated at a frequency of 6 Hz and an amplitude of 1 inch (25.4 mm), shall not exceed 25 PPM and 5% respectively.

3.8.5 Humidity

The cable assembly shall be capable of withstanding the humidity requirements of MIL-STD-810, Method 507, Procedure III.

3.9 WORKMANSHIP

The cable assembly shall be manufactured and processed in such a manner as to be uniform in quality and shall be free from cracked or displaced parts, sharp edges, burrs, and other defects that will effect life and reliability.

4. QUALITY ASSURANCE PROVISIONS

4.1 GENERAL

The quality assurance provisions of MIL-C-17 shall apply with the exceptions and additions specified herein.

4.2 RESPONSIBILITY FOR INSPECTION

Micro-Coax, Inc. is responsible for the performance of all inspection and test specified herein. Micro-Coax, Inc. may use their own facilities or other suitable inspection services.

4.3 SOURCE INSPECTION

If source inspection is required, it must be specified

MICRO-COAX [®] <i>Leading the way in transmission line solutions.</i>	FSCM NO. 64639	DWG. NO. A-16048	REV. A
	SCALE NONE	DWG SIZE A	PAGE 17 OF 25

4.4 INSPECTION LOT

An inspection lot shall be defined as a production group which is manufactured in accordance with the same design and in an essentially continuous production run using the same materials and processes.

4.5 QUALIFICATION TESTS

Cable assemblies supplied under this specification shall be capable of being tested and passing the qualification tests according to Table 3. Qualification shall consist of tests for both cable and assemblies. Qualification testing shall occur whenever a design change is made or a minimum of every 5 years.

4.5.1 Test Samples

No.	Cable Type	Connector Type (Both Ends)	Length (in)	Quantity
1	UFA147B	3.5 mm Plug	120 (3.05 m)	3
2	UFA147B	3.5 mm Plug	60 (1.52 m)	3
3	UFA147B	3.5 mm Plug	36 (0.91 m)	3
4	UFA147B	3.5 mm Plug	12 (0.30 m)	3
5	UFA147B	None	120 (3.05 m)	3
6	UFA147B	None	24 (0.61 m)	3
7	UFA147B	None	12 (0.30 m)	3

Table 3 UFA147B Test Samples

4.6 ACCEPTANCE TESTING

Acceptance testing shall consist of Group A, B, and C inspection.

4.6.1 Group A Inspection

Group A Inspection per Table 5 shall be performed on all cable assemblies supplied under this specification.

4.6.2 Group B Inspection

Group B Inspection shall be performed on a sampling of cable assemblies supplied under this specification as detailed in Table 5

4.6.3 Group C Inspection

Group C Inspection as detailed in Table 5 shall be performed on each raw cable lot used in the cable assemblies supplied under this specification.

4.7 TEST METHODS

All measurements shall be made at room temperature and prevailing barometric pressure.

4.7.1

Insertion Loss

Insertion loss shall be measured on an automatic network analyzer in accordance with the applicable paragraph of MIL-C-17. The frequency range shall be from 0.05 to 26.5 GHz or as limited by the connectors. Markers shall be placed at 1, 10, 18, and 26.5 GHz. The marker frequencies shall be used for pass/fail criteria. A scale shall be chosen so that the vertical displacement of the graphical display (trace) will cover at least 50% of the screen.

4.7.2

SWR

SWR shall be measured on an automatic network analyzer in accordance with the applicable paragraph of MIL-C-17. The frequency range shall be from 0.05 to 26.5 GHz. Limit lines shall be set as required. The limit lines shall be used for pass/fail criteria.

4.7.3

Cable Dimensions

Finished cable shall be dismantled layer by layer and diameters measured using a micrometer with an accuracy of 0.0001 inch (0.0025 mm) minimum.

4.7.4

Minimum Static Bend Radius

Connect one end of cable to a Time Domain Reflectometer (TDR) with a rise time not greater than 150 picoseconds and observe the impedance profile. Then wrap cable around specified mandrel. The impedance profile shall not change more than the specified limit.

4.7.5

Minimum Dynamic Bend Radius

Install specified mandrels and connect one end of cable to flex (tic-toc) machine arm and hang a 5 pound (2.27 kg) weight on other end. Flex machine shall be capable of ± 90 degrees of movement with an accuracy of ± 5 degrees. Flex cable for specified number of cycles and then re-measure insertion loss and SWR per 4.7.1 and 4.7.2 respectively. Confirm that insertion loss and SWR are still within the specified limits.

4.7.6

Flex Life

Connect both ends of cable to flex (snake) machine. Flex machine shall be capable of 18 inches (457.2 mm) of movement with an accuracy of ± 1 inch (25.4 mm). Flex cable for specified number of cycles and then re-measure insertion loss and SWR per 4.7.1 and 4.7.2 respectively. Confirm that insertion loss and SWR are still within the specified limits.

4.7.7

Cable Weight

Measure cable length to an accuracy of ± 0.05 inch (12.7 mm). Then measure weight in grams using a scale with an accuracy of 0.01 grams minimum. Confirm that the measured weight is below the specified limit.

 <i>Leading the way in transmission line solutions.</i>	FSCM NO. 64639	DWG. NO. A-16048	REV. A
	SCALE NONE	DWG SIZE A	PAGE 19 OF 25

- 4.7.8 Cable Dimensional Stability**
 Flush cut cable ends and verify that all cable layers are within 0.01 inch to the end of the center conductor. Thermal shock cable for 40 cycles at -65 degrees C to +125 degrees C in accordance with MIL-STD-202, Method 107. Then measure the recession of any of the cable layers to confirm that they are within the specified limits.
- 4.7.9 Cable Compression Resistance**
 Lay cable between 3 ± 0.1 inch (76.2 ± 2.54 mm) parallel plates and apply the specified compressive force. The device applying the compressive force shall have an accuracy of 0.5 pounds (0.227 kg) minimum. Visually examine cable for damage and re-measure insertion loss and SWR per 4.7.1 and 4.7.2 respectively. Confirm that insertion loss and SWR are still within the specified limits.
- 4.7.10 Connector Retention**
 Connect one end of cable to a fixed point and hang the specified weight on the other end for 1 minute minimum. Visually examine cable for damage and re-measure insertion loss and SWR per 4.7.1 and 4.7.2 respectively. Confirm that insertion loss and SWR are still within the specified limits.
- 4.7.11 Coupling Mechanism Proof Torque**
 Using a torque wrench with a minimum accuracy of ± 0.5 pounds (0.227 kg), tighten connector coupling mechanism to a mating connector with the specified force in accordance with MIL-PRF-39012. Examine coupling mechanism for damage, misalignment, or any signs of being dislodged from the connector body. Loosen coupling mechanism and inspect per the requirement specified.
- 4.7.12 Assembly Length**
 Cable assembly length shall be determined by measuring the distance from connector reference plane to connector reference plane using a measuring device with an accuracy of 0.05 inch minimum. For right angle connectors measure from the connector center line.
- 4.7.13 Assembly Marking**
 Visually examine assembly markers and compare to the requirement.
- 4.7.14 Insertion Loss Versus Temperature**
 Place cable assembly inside of a thermal chamber that has an accuracy of ± 5 degrees Celsius minimum., and connect to test leads from an automatic network analyzer. The entire assembly must be inside the thermal chamber. Use standard routines for removing any test lead contribution from the measurement. Measure insertion loss at room temperature per 4.7.1. Lower temperature to -65 degrees C and repeat measurement. Gradually increase temperature and measure insertion loss at -40, -20, 0, 20, 25, 40, 60, and 100 degrees C. Plot results and compare to requirement.

4.7.15 Phase Stability Versus Temperature

Place cable assembly inside of a thermal chamber that has an accuracy of ± 5 degrees Celsius, and connect to test leads from an automatic network analyzer. The entire assembly must be inside the thermal chamber. Use standard routines for removing any test lead contribution from the measurement. Phase at room temperature. Lower temperature to -65 degrees C and repeat measurement. Gradually increase temperature and measure phase at -40, -20, 0, 20, 25, 40, 60, and 100 degrees C. Plot results and compare to requirement.

4.7.16 Impedance

Connect one end of cable to a Time Domain Reflectometer (TDR) and compare cable impedance to a 50 ohm air-line standard in accordance with the applicable paragraph of MIL-C-17.

4.7.17 Capacitance

Measure cable length to an accuracy of ± 0.05 inch. Then measure capacitance in picofarads in accordance with the applicable paragraph of MIL-C-17. Divide the measured capacitance by the length to determine the capacitance per foot and confirm that it is within the specified limit.

4.7.18 Velocity of Propagation

Measure cable length to an accuracy of ± 0.05 inch (1.27 mm). Then connect cable assembly to an automatic network analyzer and measure group delay. Calculate the velocity of propagation using the following equation:

$$V \text{ of } P = 101.6 \times \text{Length (ft)} / \text{Group Delay (ns)}$$

4.7.19 Phase Change Versus Bending

Using no test leads, connect both ends of the cable assembly to an automatic network analyzer. Normalize the phase using divide by memory function or equivalent. Disconnect one end of the cable assembly and wrap cable one time (360°) around the specified mandrel diameter. Reconnect loose end of the cable assembly to automatic network analyzer and observe the phase change to determine if it is within the specified limits.

4.7.20 Phase Tracking Versus Temperature

Place cable assembly inside of a thermal chamber that has an accuracy of ± 5 degrees Celsius, and connect to test leads from an automatic network analyzer. The entire assembly must be inside the thermal chamber. Use standard routines for removing any test lead contribution from the measurement. Phase at room temperature. Lower temperature to -65 degrees C and repeat measurement. Gradually increase temperature and measure phase at -40, -20, 0, 20, 25, 40, 60, and 100 degrees C. Plot results and compare to requirement.

 <i>Leading the way in transmission line solutions.</i>	FSCM NO. 64639	DWG. NO. A-16048	REV. A
	SCALE NONE	DWG SIZE A	PAGE 21 OF 25

4.7.21 RF Shielding

The cable assembly shall be placed in reverberation chamber outfitted with a mode stirrer in accordance with MIL-STD-1344, Method 3008. A continuous wave signal shall be generated, amplified, and transmitted into the chamber via a double ridged horn antenna. A spectrum analyzer shall be used to measure power coupled out of the chamber via a second double ridged horn antenna. A separate analyzer shall be used to measure the power coupled out of the chamber by the assembly. To perform the measurement, a system calibration shall be obtained from .05 to 18 GHz to determine the cable/adaptor losses and antenna gains for each path. Next, system dynamic range shall be obtained by measuring a well shielded load. Then, one end of the assembly shall be connected to a spectrum analyzer and the other end to a 50 ohm shielded load. Measurements shall be made at the specified frequency range with a 2 GHz step size. The RF shielding shall be calculated per the following:

$$\text{RF Shielding} = P_{\text{CABLE}} - P_{\text{REF}} - \text{Cal Factor}$$

Where P_{CABLE} is the signal measured through the assembly, P_{REF} is the incident signal in the chamber, and Cal Factor is the measured combination of test cable/adaptor loses and antenna gains.

4.7.22 Corona Extinction

Strip one inch of the outer shield, exposing the dielectric, from both ends of the cable to be tested. Connect one end of cable to test leads of corona test set and measure in accordance with the applicable paragraph of MIL-C-17.

4.7.23 Dielectric Withstanding Voltage

Strip one inch of the outer shield, exposing the dielectric, from both ends of the cable to be tested. Connect one end of cable to test leads of dielectric withstanding voltage test set and measure in accordance with the applicable paragraph of MIL-C-17.

4.7.24 Thermal Shock

Thermal shock cable assembly for 40 cycles at -65 degrees C to +125 degrees C in accordance with MIL-STD-202, Method 107, and then remeasure insertion loss and SWR per 4.7.1 and 4.7.2 respectively. Confirm that insertion loss and SWR are still within the specified limits.

4.7.25 Cold Bend

Wrap cable around a 0.5 inch (12.7 mm) mandrel 10 times and secure the ends. Place cable inside of thermal chamber and condition at -40 degrees C for 20 hours minimum. Remove cable from chamber and visually examine jacket per the specified criteria.

- 4.7.26 Stress Crack Resistance**
Wrap cable around a 0.5 inch (12.7 mm) mandrel 10 times and secure the ends. Place cable inside of thermal chamber and condition at 230 degrees C for 96 hours minimum. Remove cable from chamber and visually examine jacket per the specified criteria.
- 4.7.27 Vibration Stability (Shake Test)**
Place coiled cable assembly on vibration table. Coil shall be loose with no tie wraps or tie downs. Connect cable assembly to an automatic network analyzer. Vibrate cable assembly at the specified frequency and amplitude. Monitor insertion loss and phase change and compare to specified limits.
- 4.7.28 Humidity**
Install sealed caps or equivalent to both connectors on the cable assembly and torque to the recommended value. Place cable assembly in thermal/humidity chamber and cycle per MIL-STD-810, Method 108, Procedure III. Then re-measure insertion loss and SWR per 4.7.1 and 4.7.2 respectively. Confirm that insertion loss and SWR are still within the specified limits.
- 4.7.29 Jacket Spark Test**
The specified voltage shall be continuously applied to the jacket in accordance with the applicable paragraph of MIL-C-17.
- 4.7.30 Connector Interface Dimensions**
Shall be measured in accordance with the applicable paragraph of MIL-PRF-39012.
- 4.7.31 Workmanship**
Visually examine cable assembly per the specified requirements.

5. PREPARATION FOR DELIVERY

- 5.1 PACKAGING**
Cable assemblies shall be packaged in shock absorbent material and placed in cardboard boxes for shipment. The cable assemblies will be loosely coiled in a diameter of approximately 16 inches (406 mm).

- 5.2 LABELING**
Any special labeling requirements must be specified.

- 6. ORDERING INFORMATION**
When ordering cable assemblies to this specification, the order must specify the assembly length, connector types, and quantity as a minimum. If additional options are required, like armoring, phase matching, or special marking, they must be clearly detailed on the order.

 <i>Leading the way in transmission line solutions.</i>	FSCM NO. 64639	DWG. NO. A-16048	REV. A
	SCALE NONE	DWG SIZE A	PAGE 23 OF 25

Sample No.	Test	Requirement	Method
1, 2, 3	Insertion Loss	3.7.2	4.7.1
1, 2, 3	SWR	3.7.3	4.7.2
6	Cable Dimensions	3.6.1	4.7.3
3	Minimum Static Bend Radius	3.6.5	4.7.4
2	Minimum Dynamic Bend Radius	3.6.6	4.7.5
3	Flex Life	3.6.7	4.7.6
5	Cable Weight	3.6.8	4.7.7
5	Cable Dimensional Stability	3.6.9	4.7.8
2	Cable Compression Resistance	3.6.10	4.7.9
4	Connector Retention	3.6.11	4.7.10
3	Coupling Mechanism Proof Torque	3.6.13	4.7.11
1, 2, 3	Assembly Length	3.6.14	4.7.12
1, 2, 3	Assembly Marking	3.6.15	4.7.13
1	Insertion Loss vs. Temperature	3.7.2.2	4.7.14
5	Impedance	3.7.4	4.7.16
5	Capacitance	3.7.5	4.7.17
1	Velocity of Propagation	3.7.6	4.7.18
3	Phase Change vs. Bending	3.7.7.1.3	4.7.19
1	Phase Stability vs. Temperature	3.7.7.2	4.7.15
1	Phase Tracking	3.7.7.3	4.7.20
1	RF Shielding	3.7.8	4.7.21
5	Corona Extinction	3.7.10	4.7.22
5	Dielectric Withstanding Voltage	3.7.11	4.7.23
6	Thermal Shock	3.8.1	4.7.24
6	Cold Bend	3.8.2	4.7.25
6	Stress Crack Resistance	3.8.3	4.7.26
1	Vibration (Shake Test)	3.8.4	4.7.27
2	Humidity	3.8.5	4.7.28

Table 4 Qualification Testing

Group	Test	Requirement	Method	Sampling
A	Insertion Loss	3.7.2	4.7.1	100%
A	SWR	3.7.3	4.7.2	100%
A	Connector Interface	3.6.2	4.7.30	100%
A	Assembly Marking	3.6.15	4.7.13	100%
A	Workmanship	3.9	4.7.31	100%
B	Assembly Length	3.6.14	4.7.12	2.5 AQL
C	Jacket Spark Test	3.7.13	4.7.29	100%
C	Impedance	3.7.4	4.7.16	100%
C	Cable Diameter	3.6.1	4.7.3	100%
C	Velocity of Propagation	3.7.6	4.7.18	2 pcs./lot
C	Vibration Stability (Shake Test)	3.8.4	4.7.27	2 pcs./lot
C	Jacket Wall Thickness	3.6.1	4.7.3	2 pcs./lot
C	Braid Diameter	3.6.1	4.7.3	2 pcs./lot
C	Inner Shield Diameter	3.6.1	4.7.3	2 pcs./lot
C	Dielectric Diameter	3.6.1	4.7.3	2 pcs./lot
C	Center Conductor Diameter	3.6.1	4.7.3	2 pcs./lot
C	Cable Weight	3.6.8	4.7.7	2 pcs./lot
C	Dimensional Stability	3.6.9	4.7.8	2 pcs./lot

Table 5 Acceptance Testing